

Chapter 3

Transport Layer

A note on the use of these PowerPoint slides:

We're making these slides freely available to all (faculty, students, readers). They're in PowerPoint form so you see the animations; and can add, modify, and delete slides (including this one) and slide content to suit your needs. They obviously represent a *lot* of work on our part. In return for use, we only ask the following:

- If you use these slides (e.g., in a class) that you mention their source (after all, we'd like people to use our book!)
- If you post any slides on a www site, that you note that they are adapted from (or perhaps identical to) our slides, and note our copyright of this material.

For a revision history, see the slide note for this page.

Thanks and enjoy! JFK/KWR

All material copyright 1996-2020
J.F Kurose and K.W. Ross, All Rights Reserved

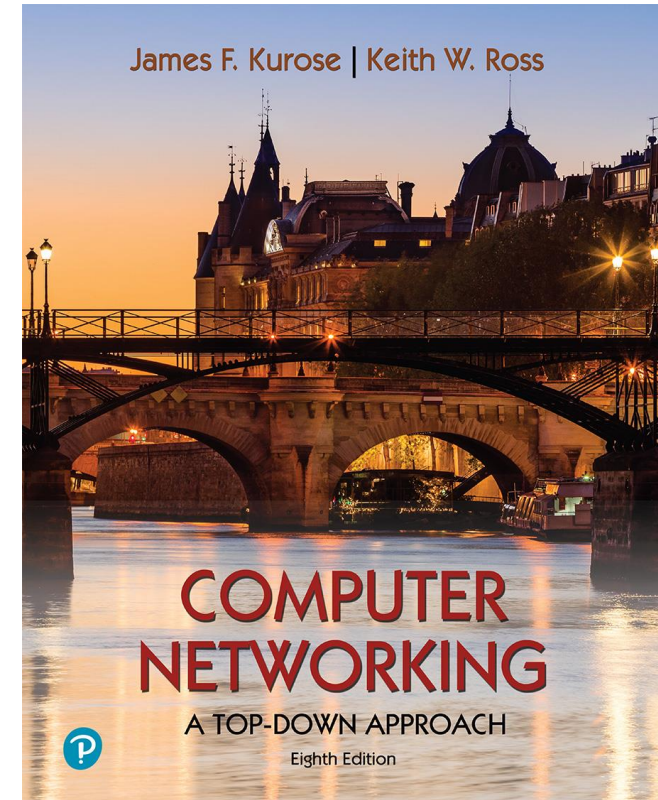

Computer Networking: A Top-Down Approach

8th edition

Jim Kurose, Keith Ross
Pearson, 2020

Transport layer: overview

Our goal:

- understand principles behind transport layer services:
 - multiplexing, demultiplexing
 - reliable data transfer
 - flow control
 - congestion control
- learn about Internet transport layer protocols:
 - UDP: connectionless transport
 - TCP: connection-oriented reliable transport
 - TCP congestion control

Transport layer: roadmap

- Transport-layer services
- Multiplexing and demultiplexing
- Connectionless transport: UDP
- Principles of reliable data transfer
- Connection-oriented transport: TCP
- Principles of congestion control
- TCP congestion control
- Evolution of transport-layer functionality



Transport services and protocols

- provide *logical communication* between application processes running on different hosts
- transport protocols actions in end systems:
 - sender: breaks application messages into *segments*, passes to network layer
 - receiver: reassembles segments into messages, passes to application layer
- two transport protocols available to Internet applications
 - TCP, UDP

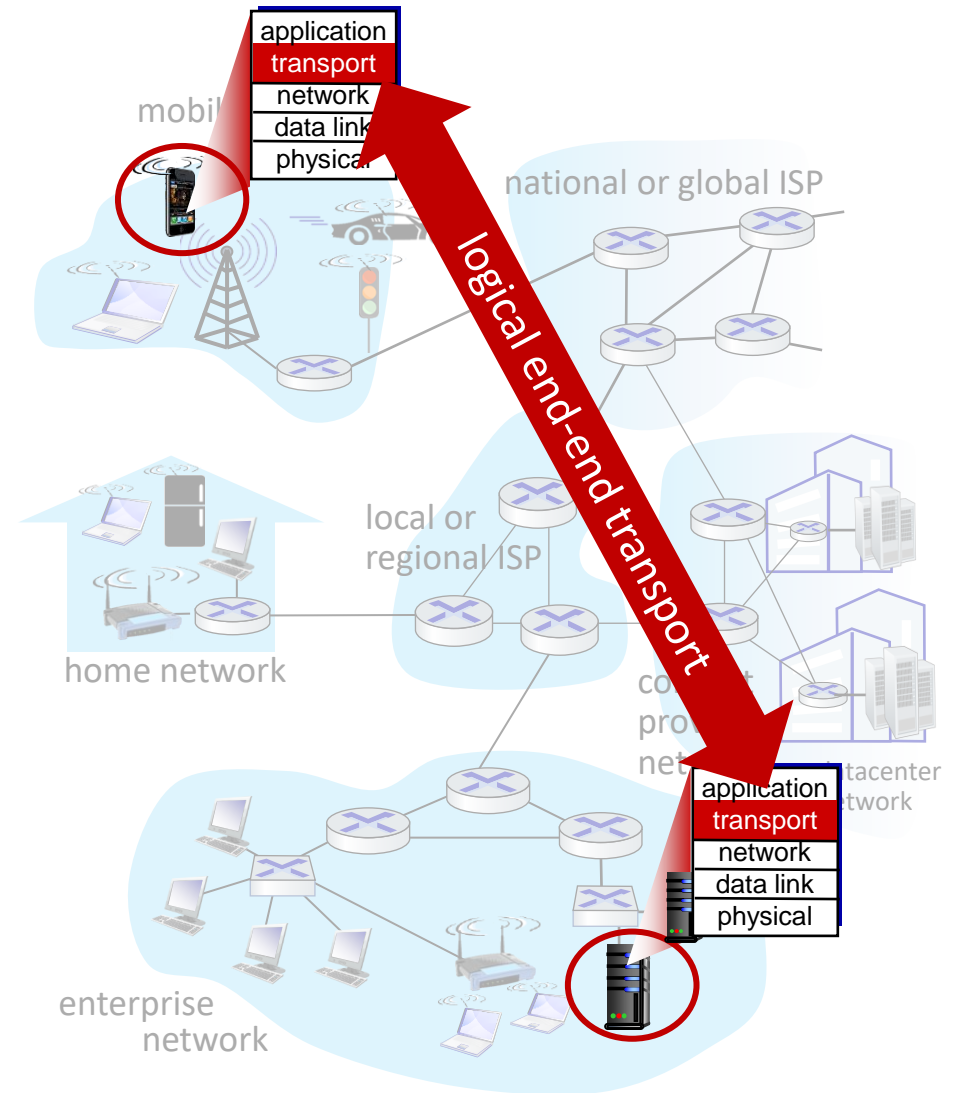

Transport vs. network layer services and protocols



household analogy:

12 kids in Ann's house sending letters to 12 kids in Bill's house:

- hosts = houses
- processes = kids
- app messages = letters in envelopes

Transport vs. network layer services and protocols

- network layer: logical communication between *hosts*
- transport layer: logical communication between *processes*
 - relies on, enhances, network layer services

household analogy:

12 kids in Ann's house sending letters to 12 kids in Bill's house:

- hosts = houses
- processes = kids
- app messages = letters in envelopes

Transport Layer Actions

Sender:

- is passed an application-layer message
- determines segment header fields values
- creates segment
- passes segment to IP

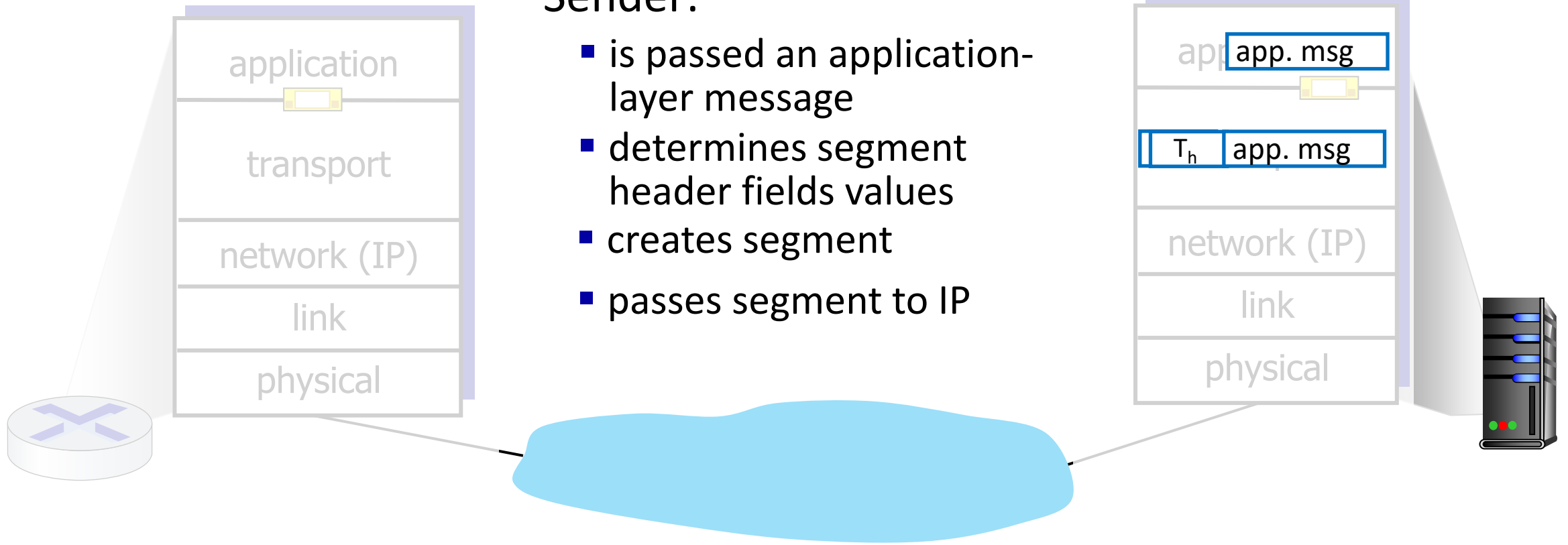

Transport Layer Actions

Receiver:

- receives segment from IP
- checks header values
- extracts application-layer message
- demultiplexes message up to application via socket

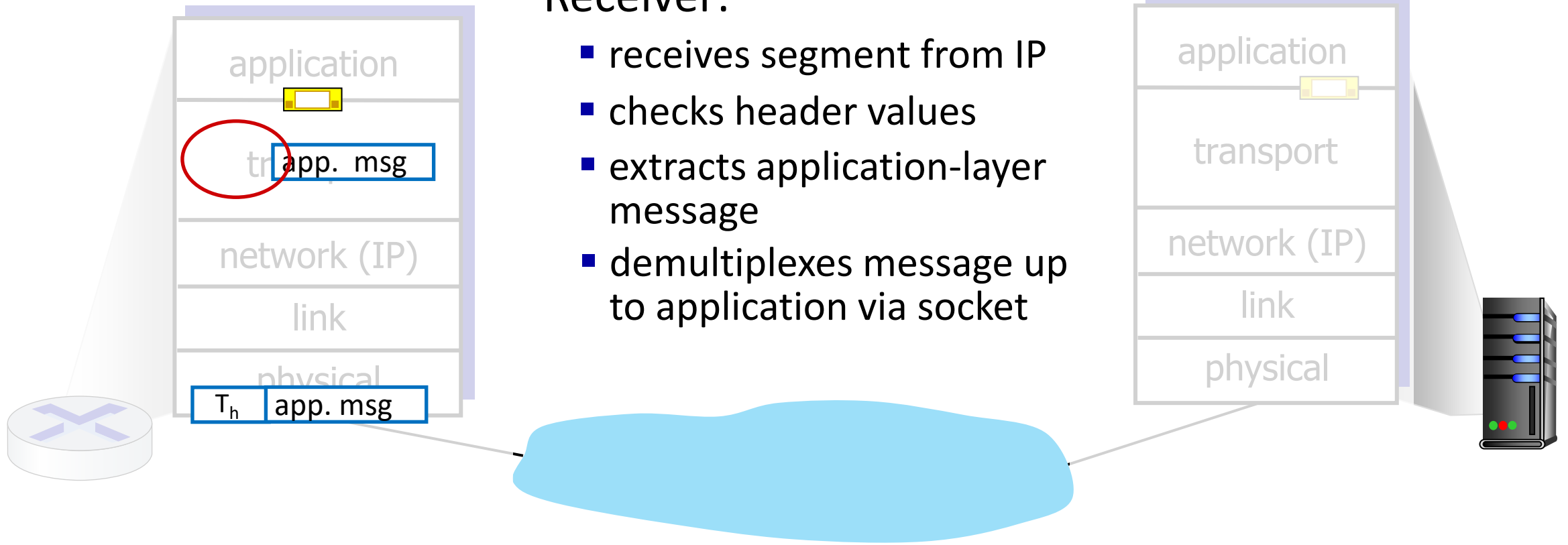

Two principal Internet transport protocols

- **TCP:** Transmission Control Protocol
 - reliable, in-order delivery
 - congestion control
 - flow control
 - connection setup
- **UDP:** User Datagram Protocol
 - unreliable, unordered delivery
 - no-frills extension of “best-effort” IP
- services not available:
 - delay guarantees
 - bandwidth guarantees

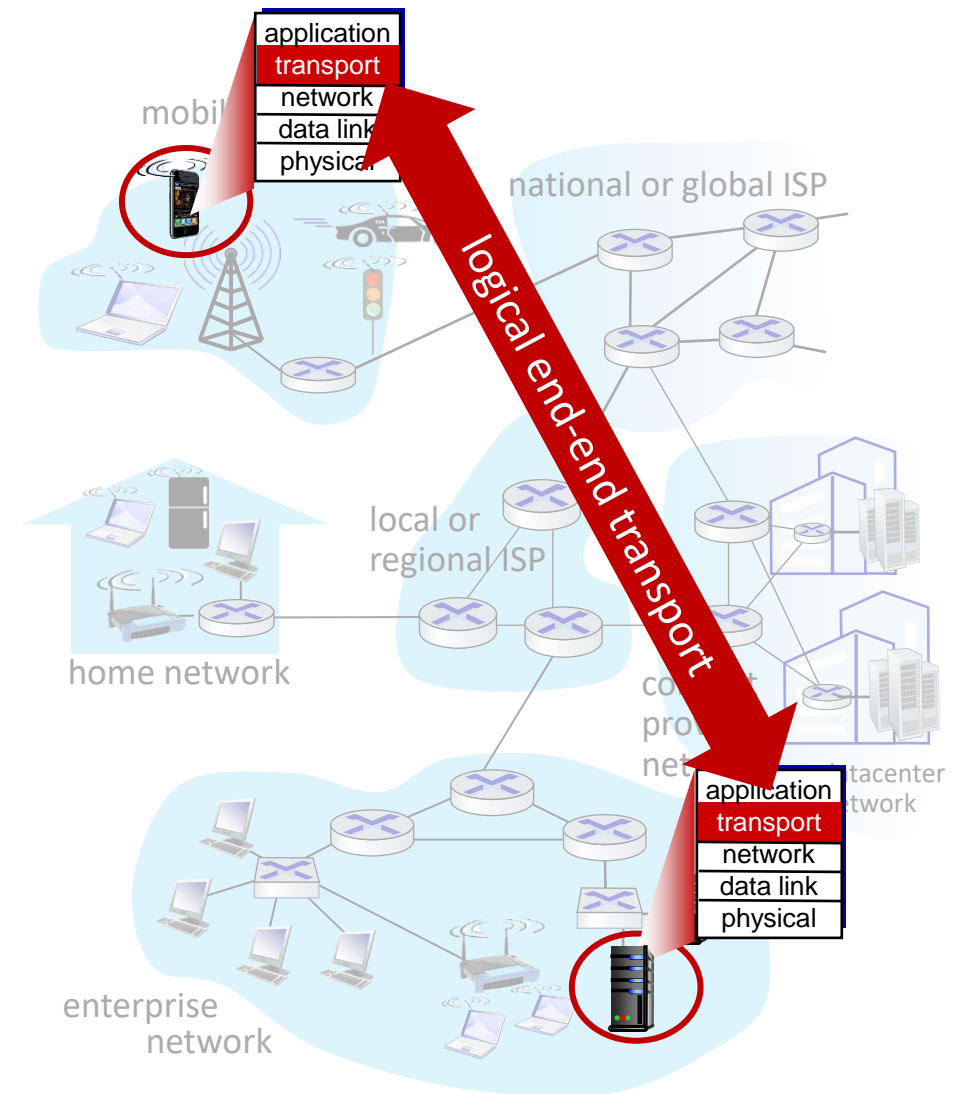

Chapter 3: roadmap

- Transport-layer services
- **Multiplexing and demultiplexing**
- Connectionless transport: UDP
- Principles of reliable data transfer
- Connection-oriented transport: TCP
- Principles of congestion control
- TCP congestion control
- Evolution of transport-layer functionality



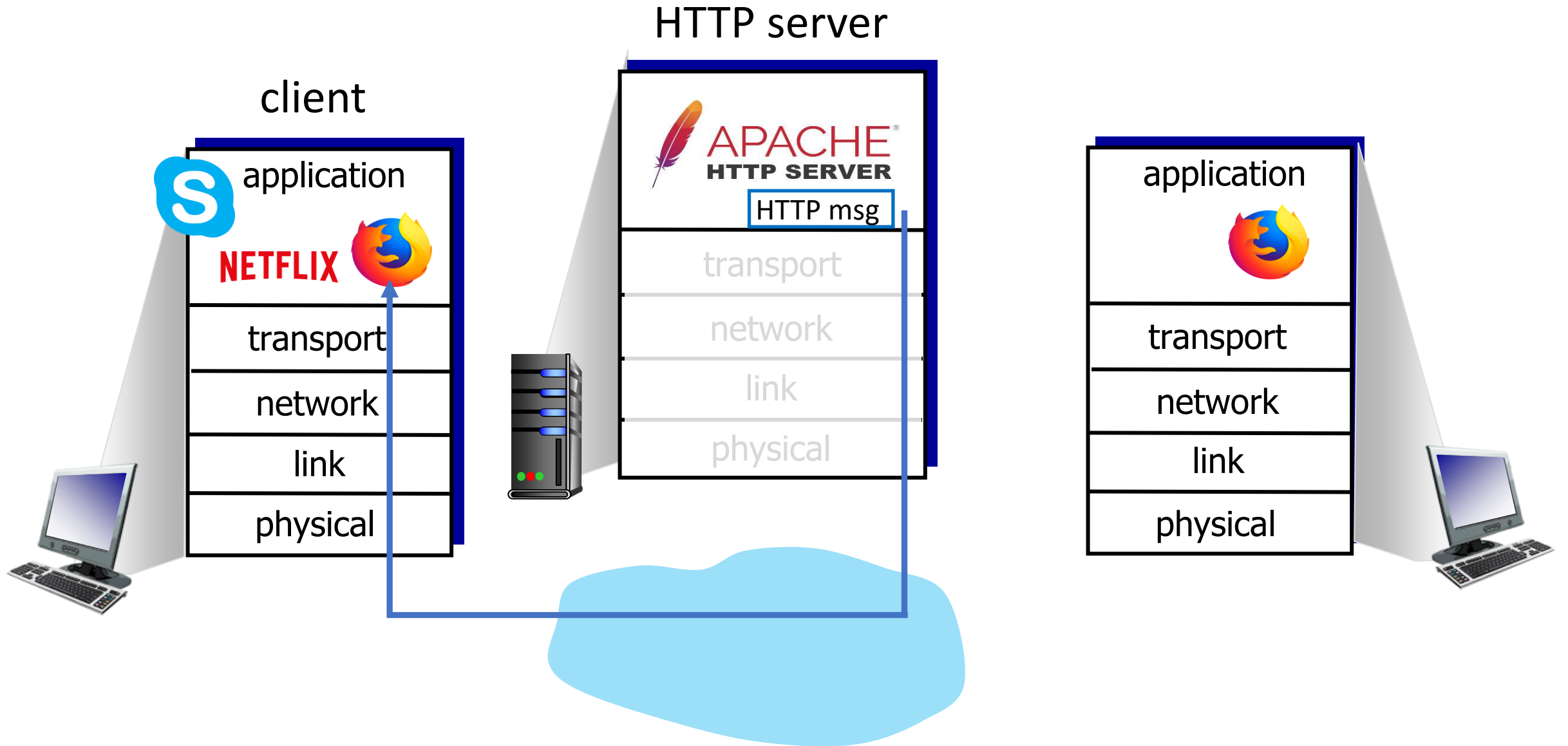

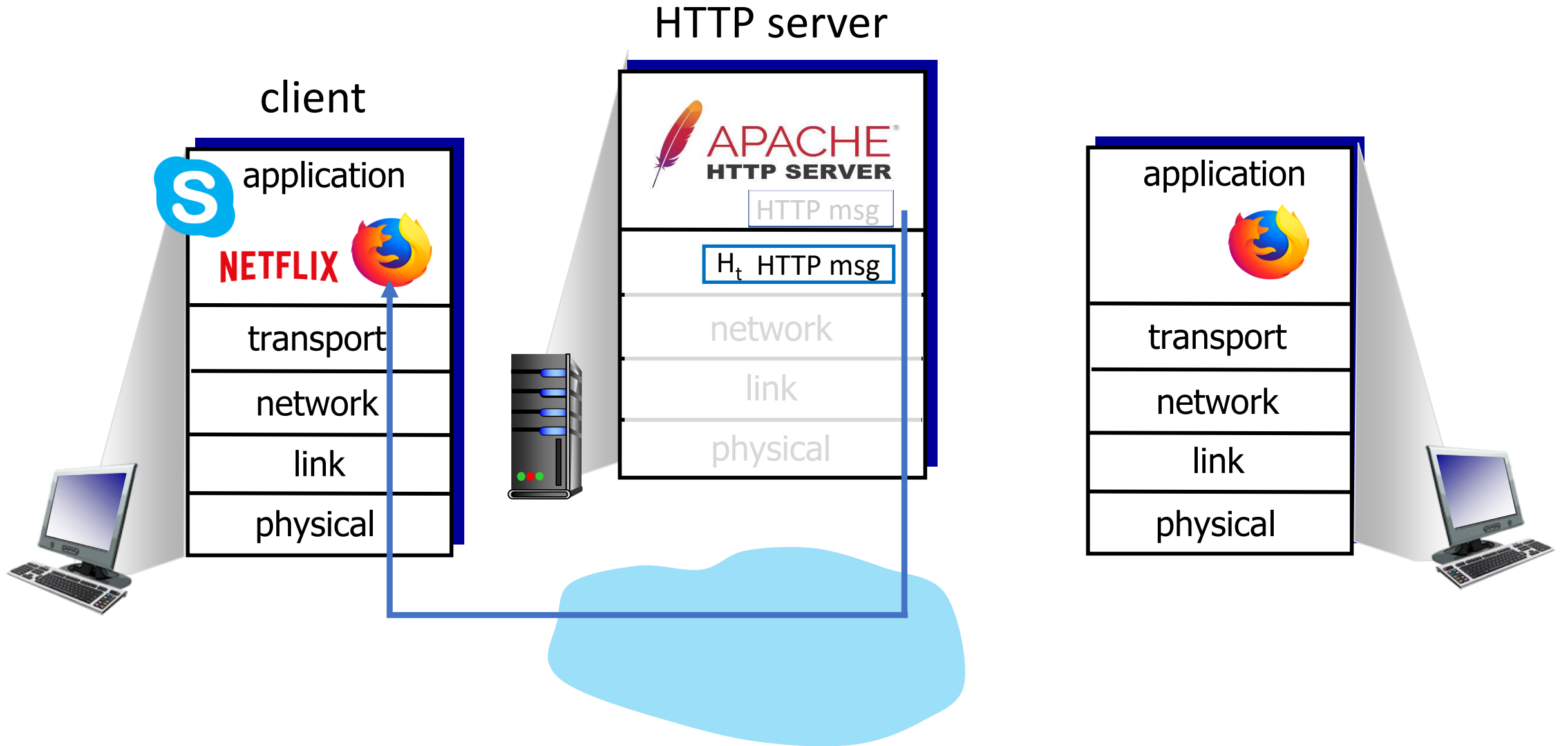

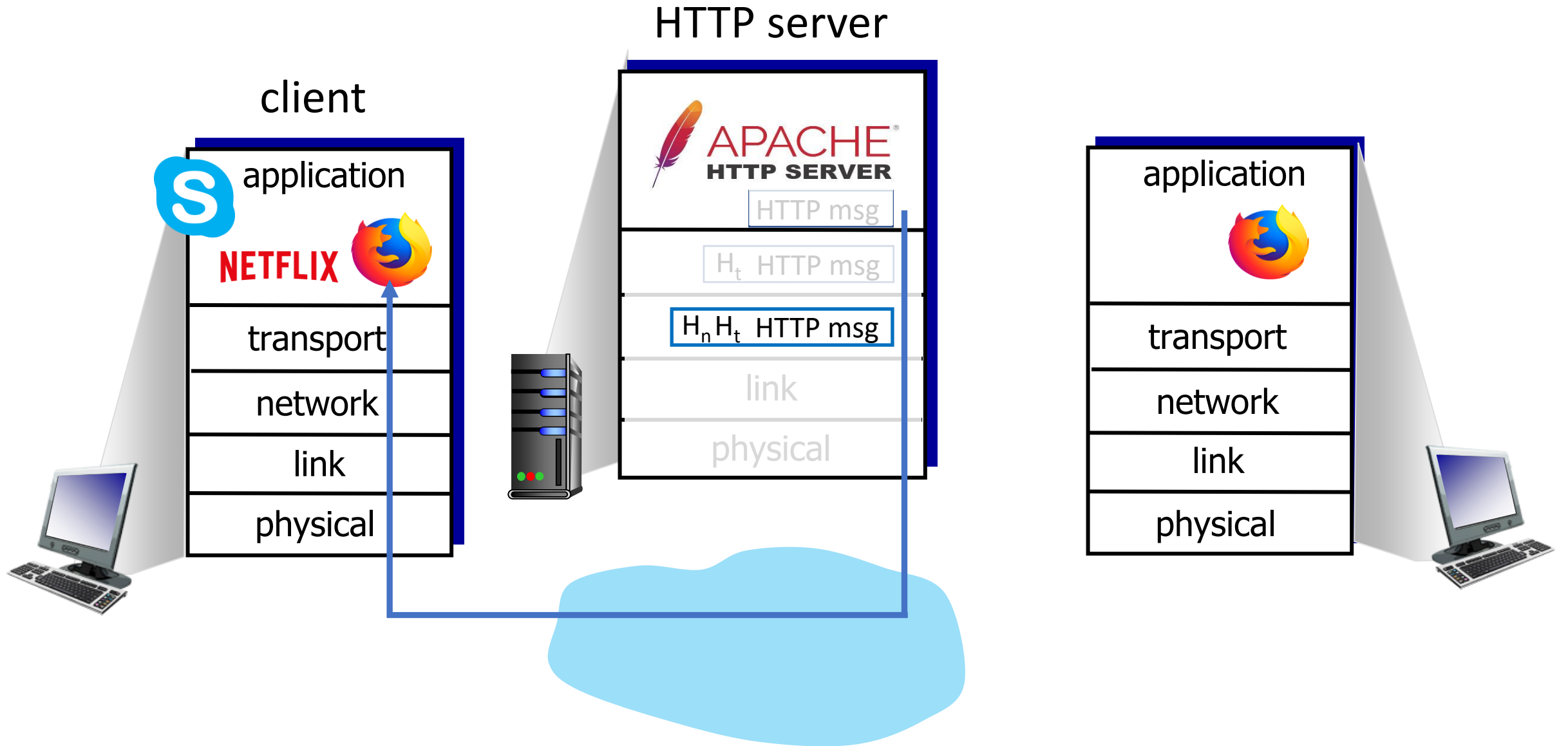

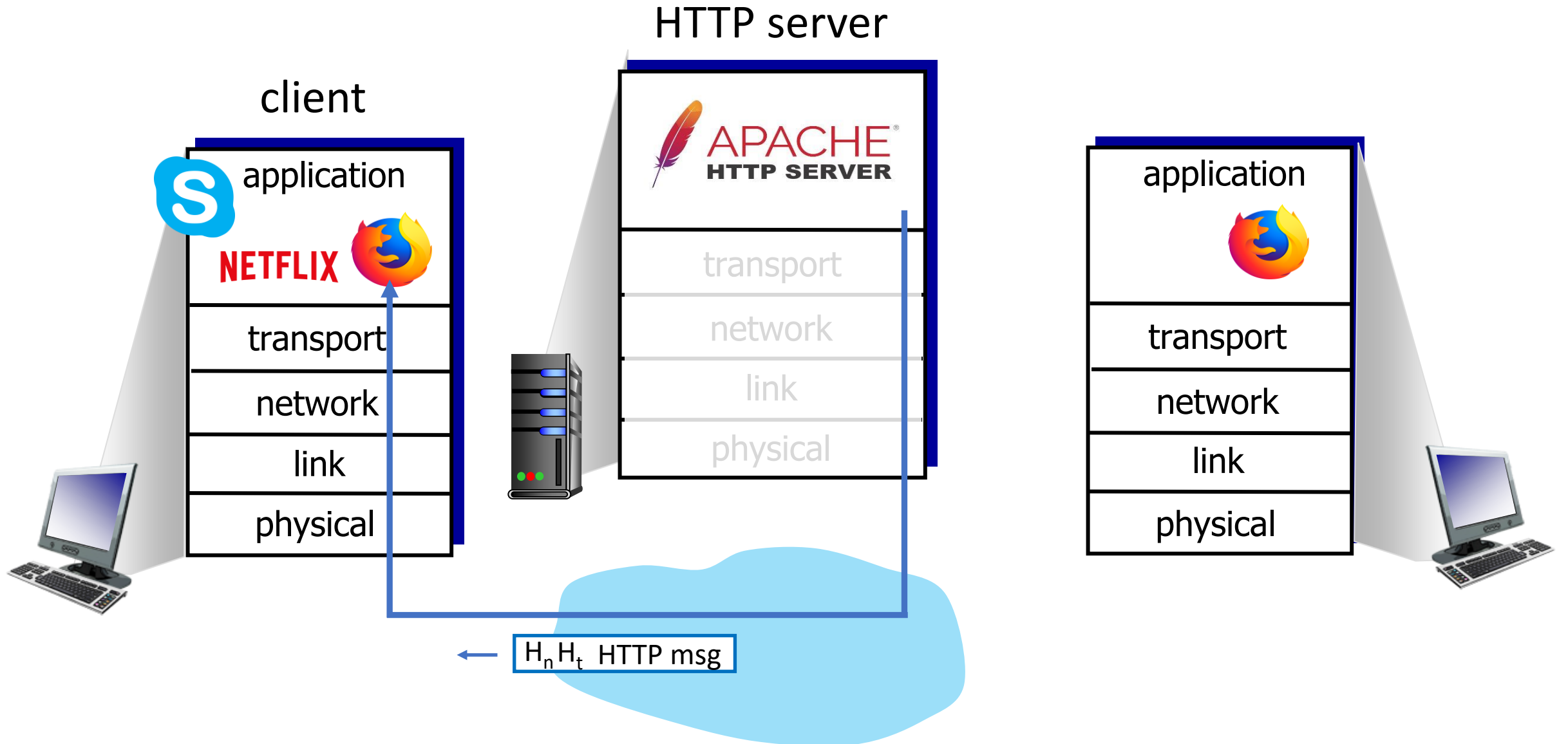

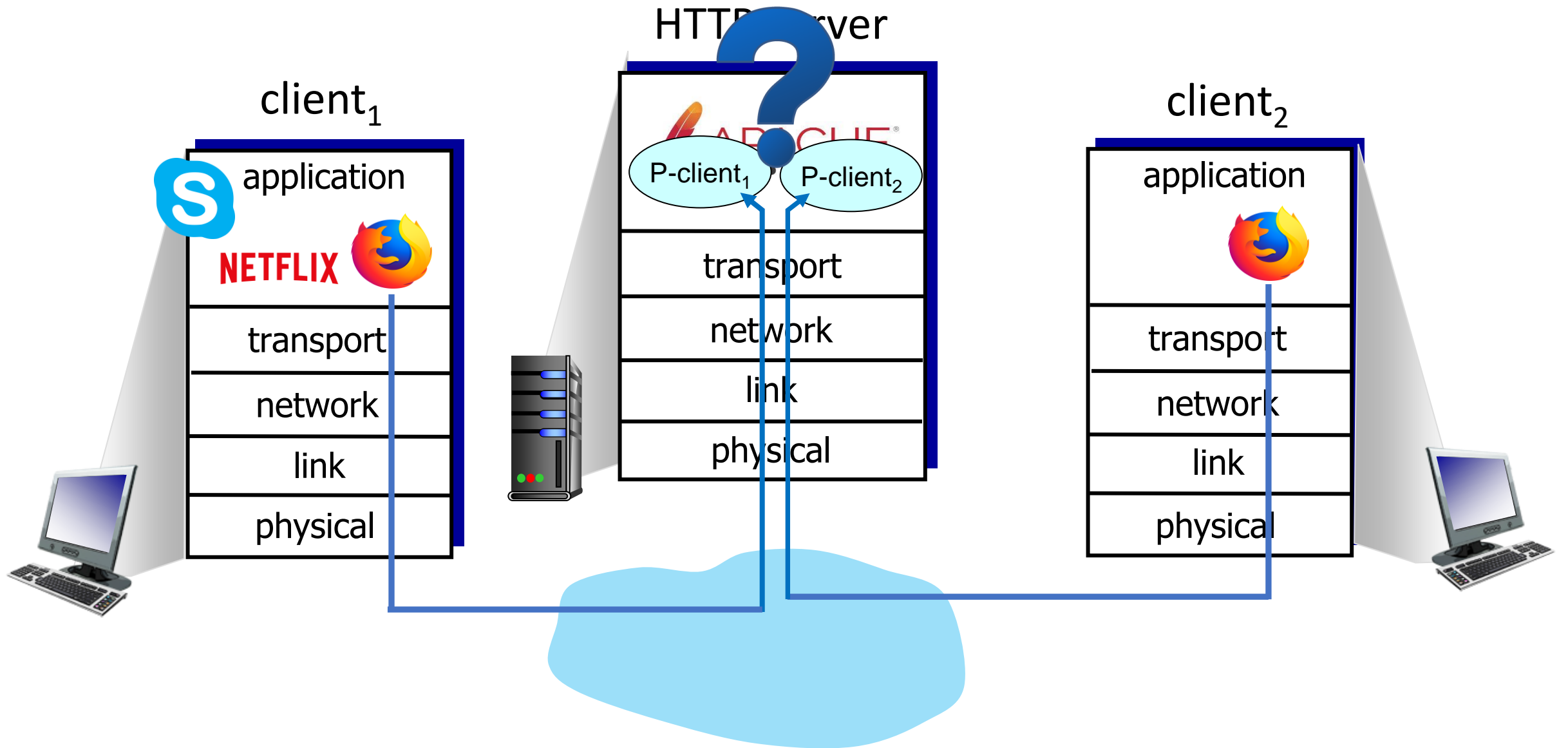

Multiplexing/demultiplexing

multiplexing at sender:

handle data from multiple sockets, add transport header (later used for demultiplexing)

demultiplexing at receiver:

use header info to deliver received segments to correct socket

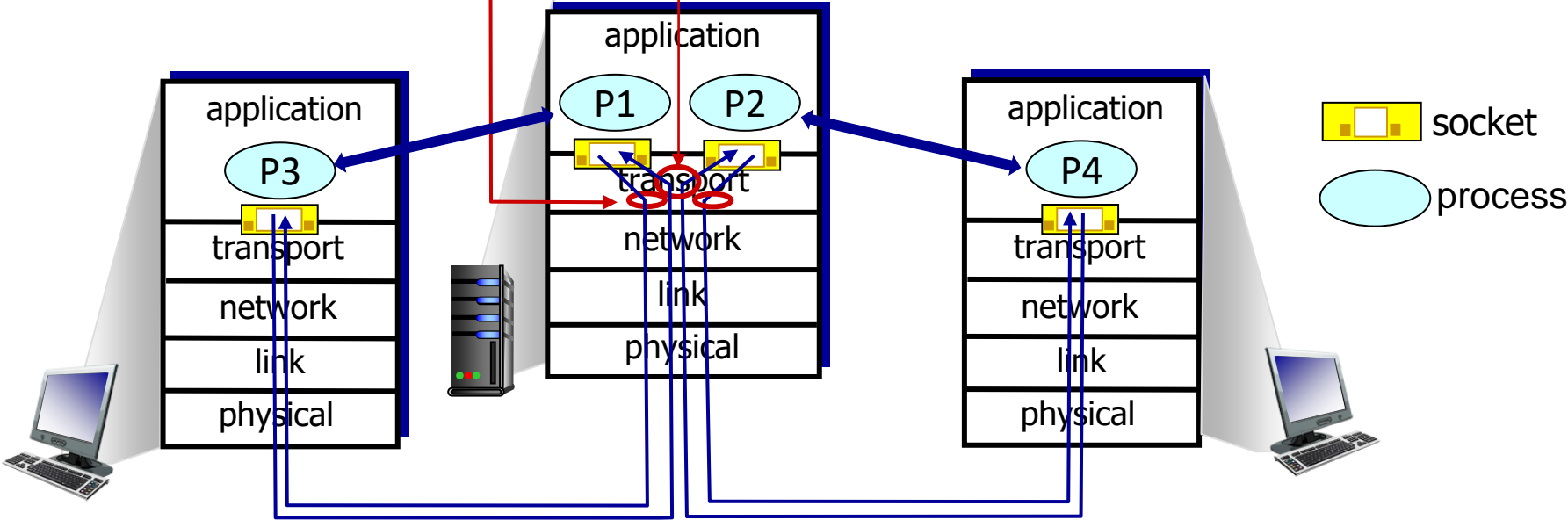

How demultiplexing works

- host receives IP datagrams
 - each datagram has source IP address, destination IP address
 - each datagram carries one transport-layer segment
 - each segment has source, destination port number
- host uses *IP addresses & port numbers* to direct segment to appropriate socket

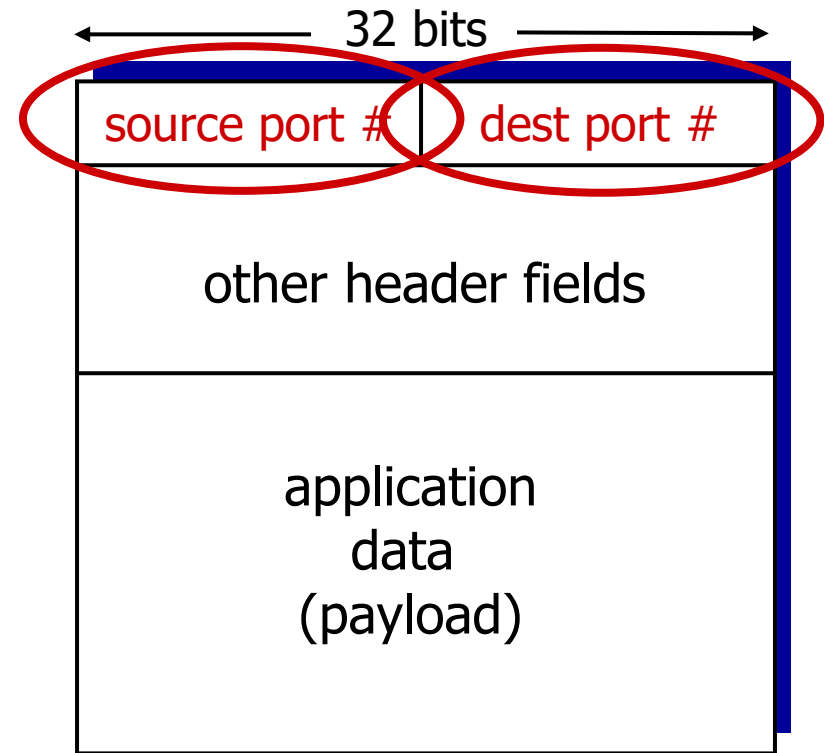

TCP/UDP segment format

Connectionless demultiplexing

Recall:

- when creating socket, must specify *host-local* port #:

```
DatagramSocket mySocket1  
= new DatagramSocket(12534);
```

- when creating datagram to send into UDP socket, must specify
 - destination IP address
 - destination port #

when receiving host receives *UDP* segment:

- checks destination port # in segment
- directs UDP segment to socket with that port #



IP/UDP datagrams with *same dest. port #*, but different source IP addresses and/or source port numbers will be directed to *same socket* at receiving host

Connectionless demultiplexing: an example

```
DatagramSocket mySocket2 =  
new DatagramSocket  
(9157);
```

```
DatagramSocket  
serverSocket = new  
DatagramSocket  
(6428);
```

```
DatagramSocket mySocket1 =  
new DatagramSocket (5775);
```

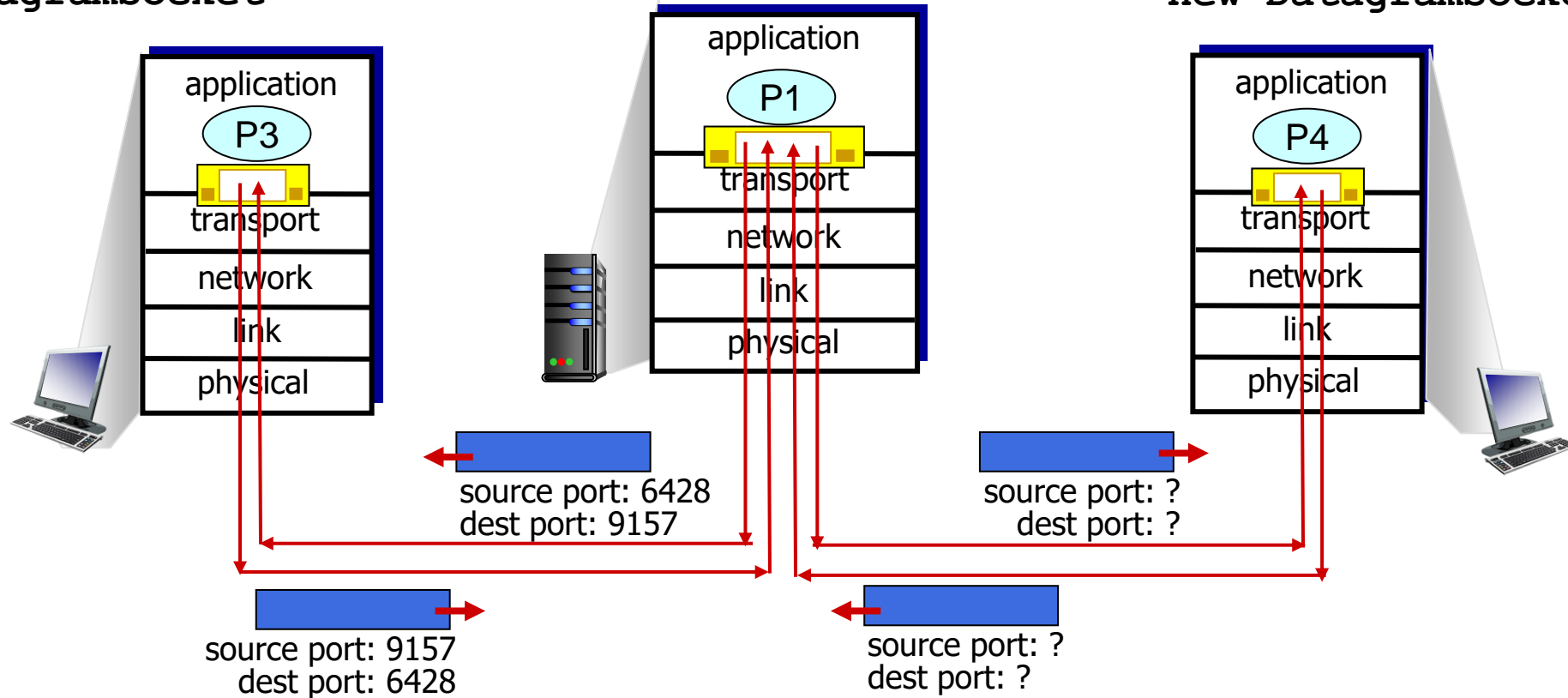

Connection-oriented demultiplexing

- TCP socket identified by 4-tuple:
 - source IP address
 - source port number
 - dest IP address
 - dest port number
- demux: receiver uses *all four values (4-tuple)* to direct segment to appropriate socket
- server may support many simultaneous TCP sockets:
 - each socket identified by its own 4-tuple
 - each socket associated with a different connecting client

Connection-oriented demultiplexing: example

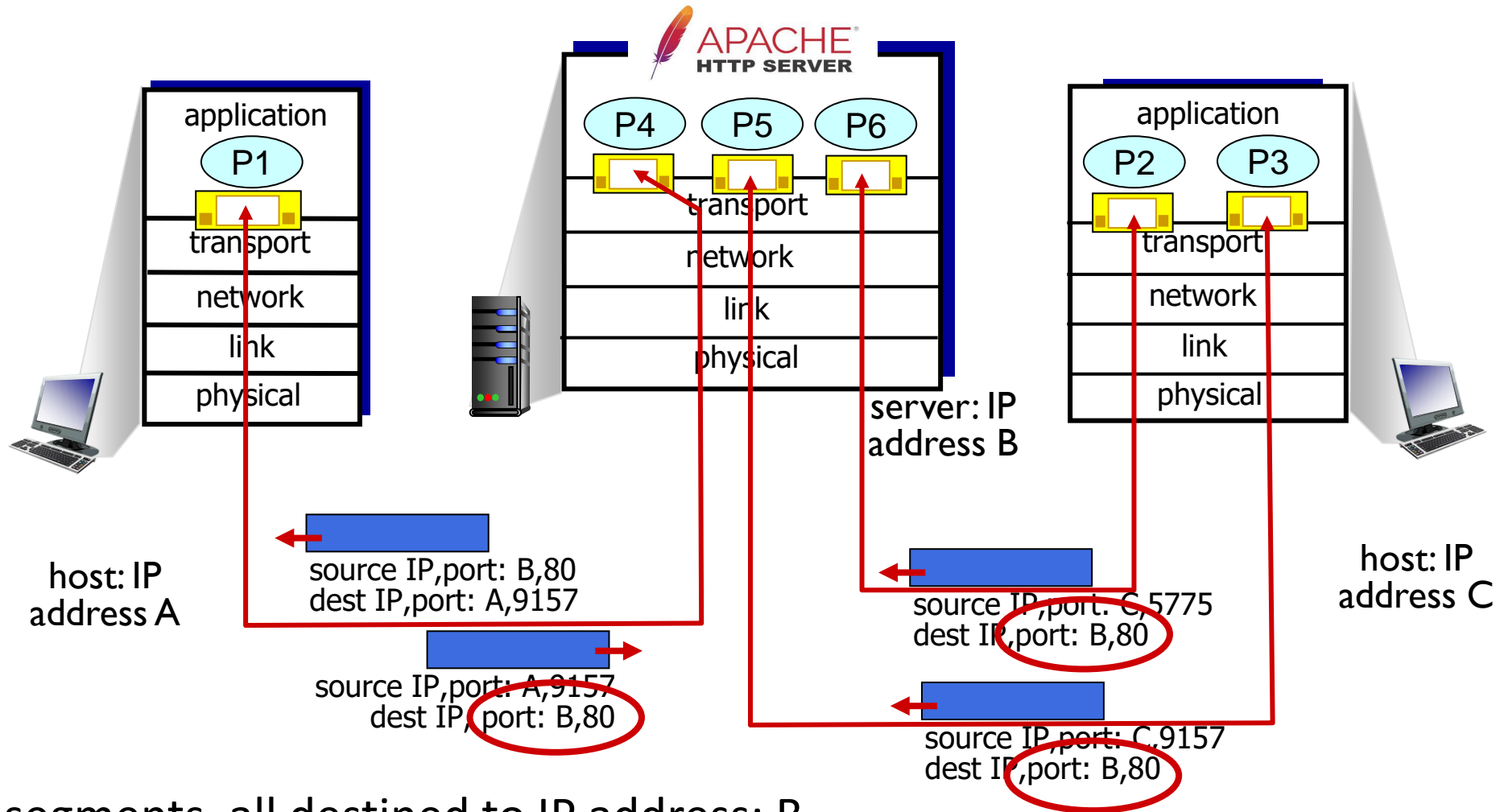

Three segments, all destined to IP address: B,
dest port: 80 are demultiplexed to *different* sockets

Summary

- Multiplexing, demultiplexing: based on segment, datagram header field values
- **UDP:** demultiplexing using destination port number (only)
- **TCP:** demultiplexing using 4-tuple: source and destination IP addresses, and port numbers
- Multiplexing/demultiplexing happen at *all* layers

Chapter 3: roadmap

- Transport-layer services
- Multiplexing and demultiplexing
- **Connectionless transport: UDP**
- Principles of reliable data transfer
- Connection-oriented transport: TCP
- Principles of congestion control
- TCP congestion control
- Evolution of transport-layer functionality



UDP: User Datagram Protocol

- “no frills,” “bare bones” Internet transport protocol
- “best effort” service, UDP segments may be:
 - lost
 - delivered out-of-order to app
- *connectionless*:
 - no handshaking between UDP sender, receiver
 - each UDP segment handled independently of others

Why is there a UDP?

- no connection establishment (which can add RTT delay)
- simple: no connection state at sender, receiver
- small header size
- no congestion control
 - UDP can blast away as fast as desired!
 - can function in the face of congestion

UDP: User Datagram Protocol

- UDP use:
 - streaming multimedia apps (loss tolerant, rate sensitive)
 - DNS
 - SNMP
 - HTTP/3
- if reliable transfer needed over UDP (e.g., HTTP/3):
 - add needed reliability at application layer
 - add congestion control at application layer

UDP: User Datagram Protocol [RFC 768]

INTERNET STANDARD

RFC 768

J. Postel

ISI

28 August 1980

User Datagram Protocol

Introduction

This User Datagram Protocol (UDP) is defined to make available a datagram mode of packet-switched computer communication in the environment of an interconnected set of computer networks. This protocol assumes that the Internet Protocol (IP) [1] is used as the underlying protocol.

This protocol provides a procedure for application programs to send messages to other programs with a minimum of protocol mechanism. The protocol is transaction oriented, and delivery and duplicate protection are not guaranteed. Applications requiring ordered reliable delivery of streams of data should use the Transmission Control Protocol (TCP) [2].

Format

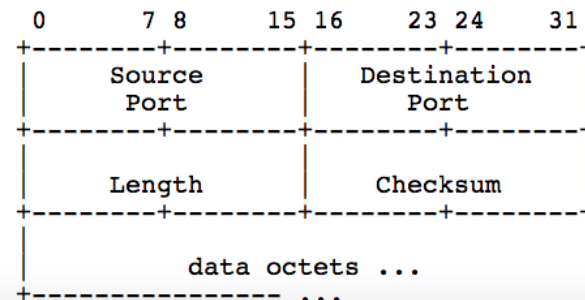

UDP: Transport Layer Actions

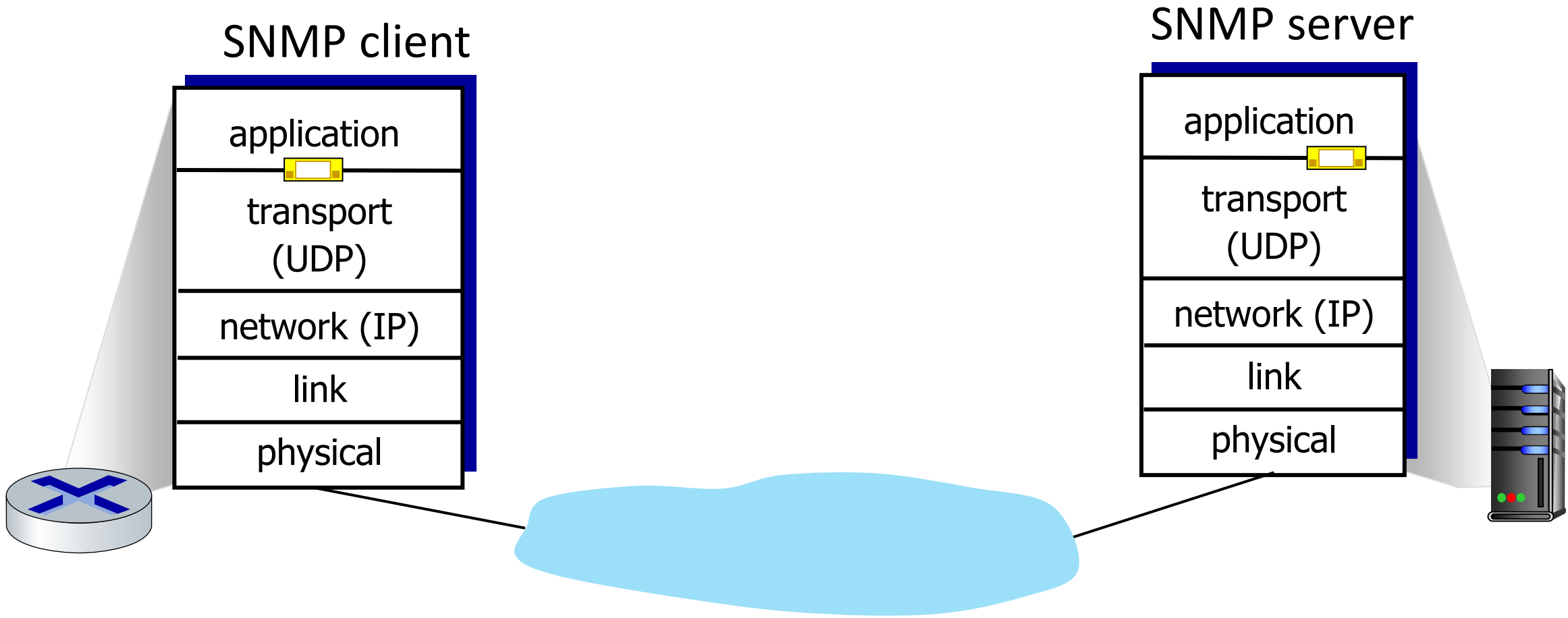

UDP: Transport Layer Actions

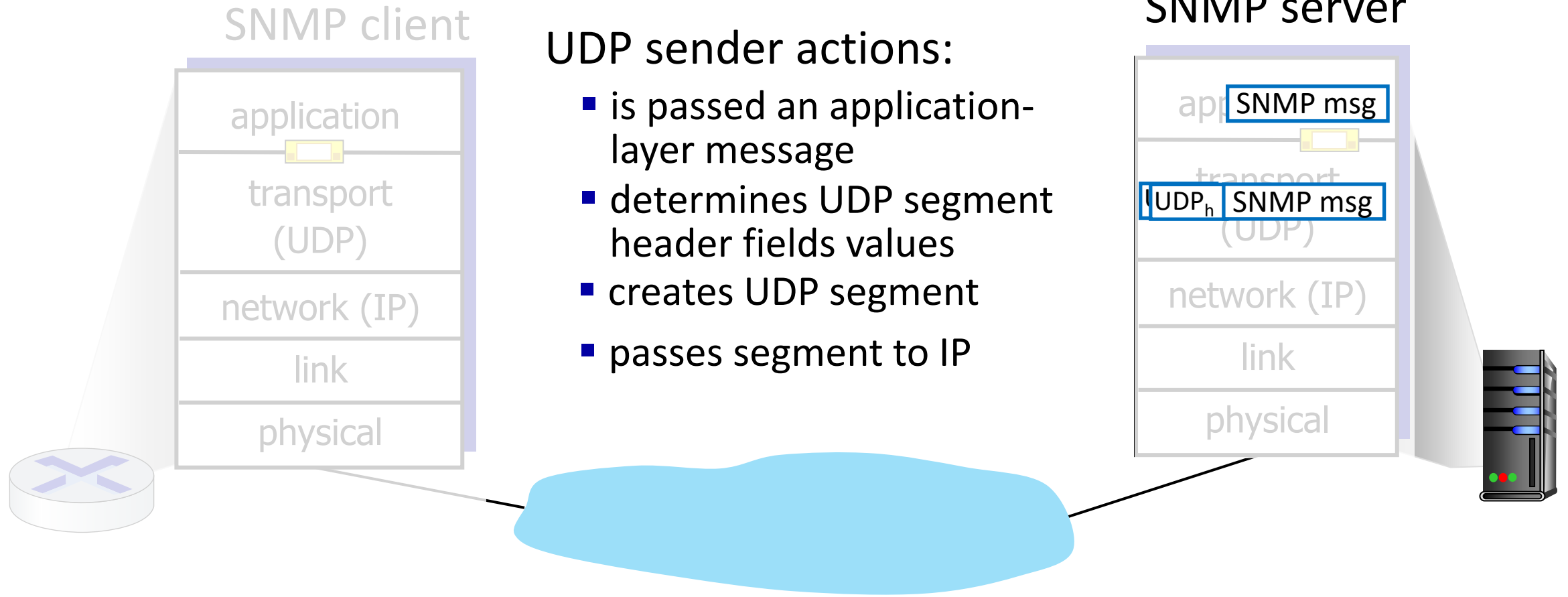

UDP: Transport Layer Actions

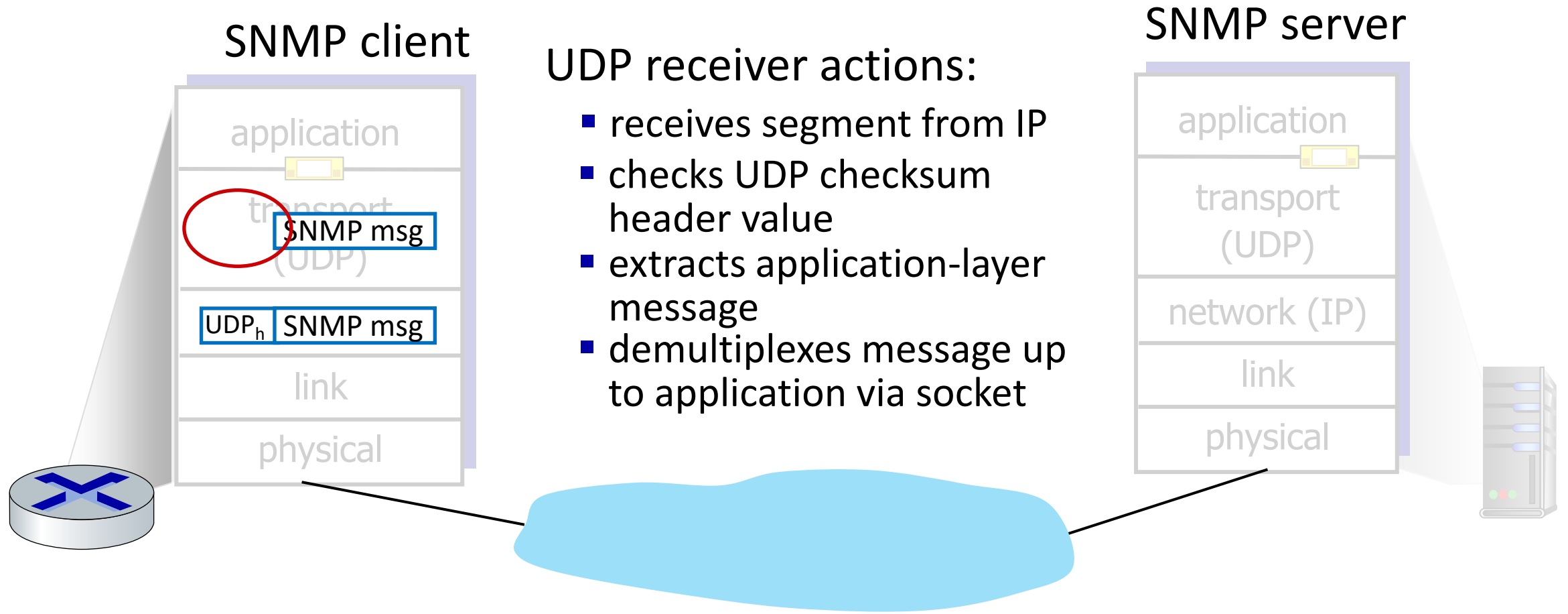

UDP segment header

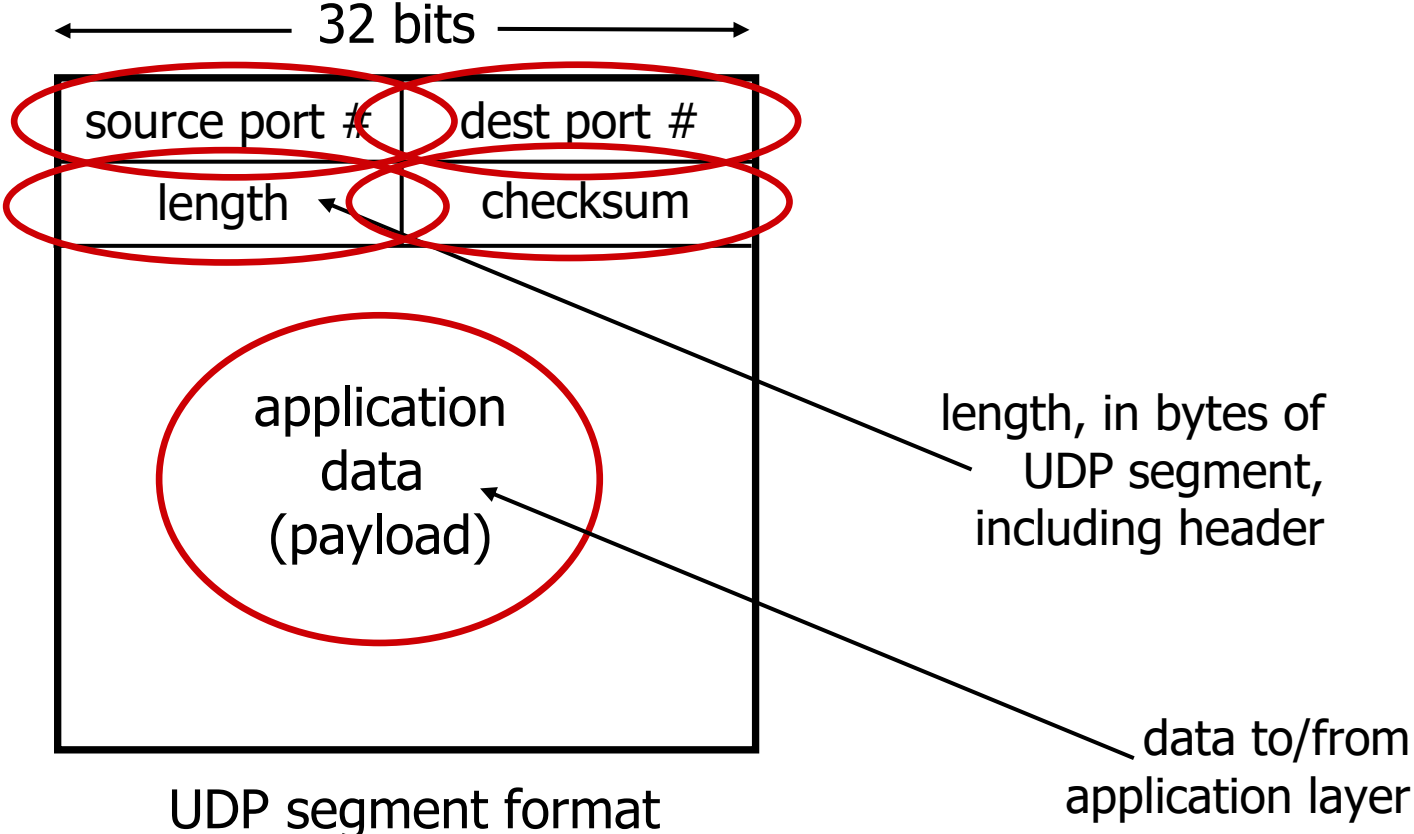

UDP checksum

Goal: detect errors (i.e., flipped bits) in transmitted segment

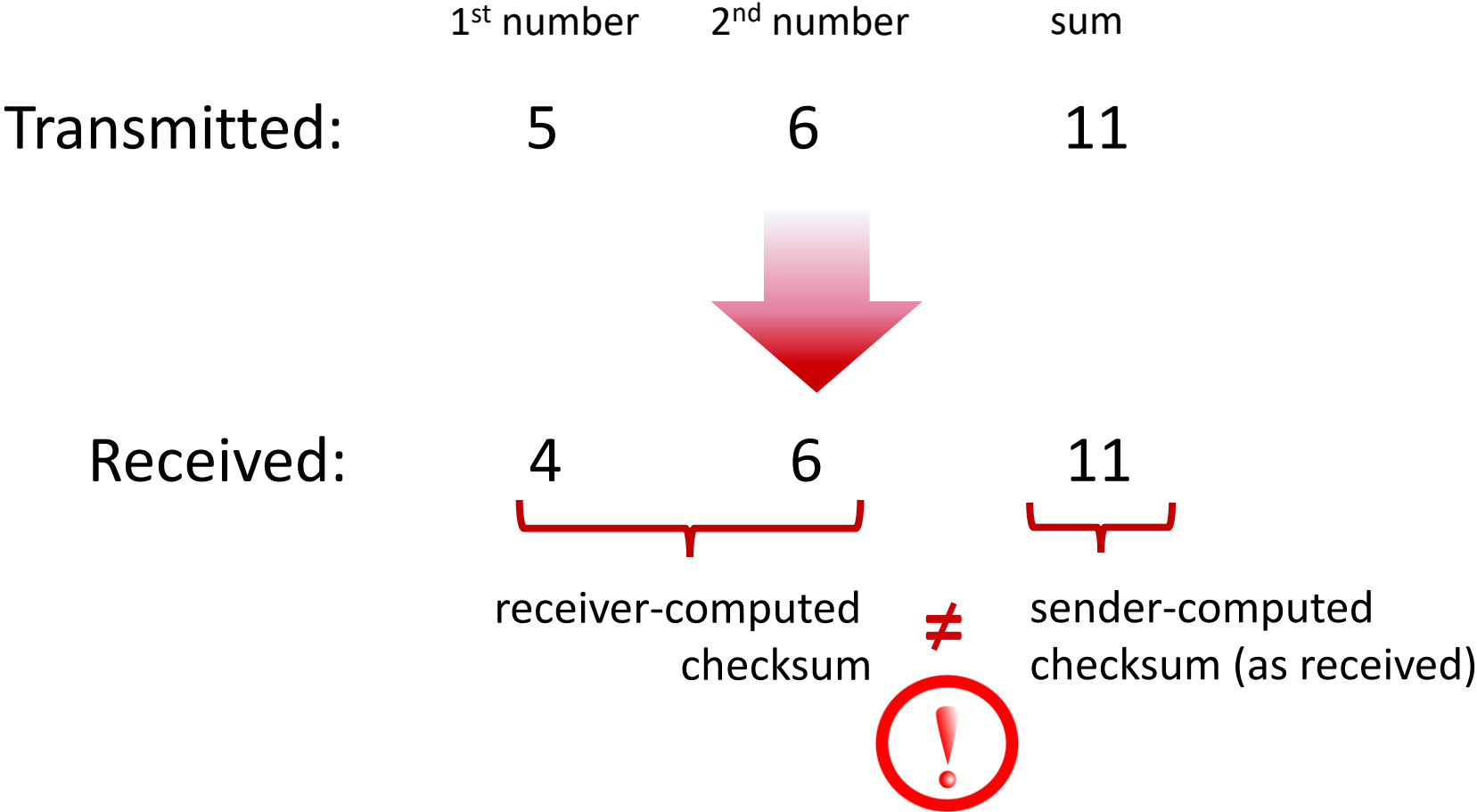

Internet checksum

Goal: detect errors (*i.e.*, flipped bits) in transmitted segment

sender:

- treat contents of UDP segment (including UDP header fields and IP addresses) as sequence of 16-bit integers
- **checksum:** addition (one's complement sum) of segment content
- checksum value put into UDP checksum field

receiver:

- compute checksum of received segment
- check if computed checksum equals checksum field value:
 - not equal - error detected
 - equal - no error detected. *But maybe errors nonetheless?* More later

Internet checksum: an example

example: add two 16-bit integers

	1	1	1	0	0	1	1	0	0	1	1	0	0	1	1	0	
	1	1	0	1	0	1	0	1	0	1	0	1	0	1	0	1	
	<hr/>																
wraparound	1	1	0	1	1	1	0	1	1	1	0	1	1	1	0	1	1
	<hr/>																
sum	1	0	1	1	1	0	1	1	1	0	1	1	1	1	0	0	
checksum	0	1	0	0	0	1	0	0	0	1	0	0	0	0	1	1	

Note: when adding numbers, a carryout from the most significant bit needs to be added to the result

* Check out the online interactive exercises for more examples: http://gaia.cs.umass.edu/kurose_ross/interactive/

Internet checksum: weak protection!

example: add two 16-bit integers

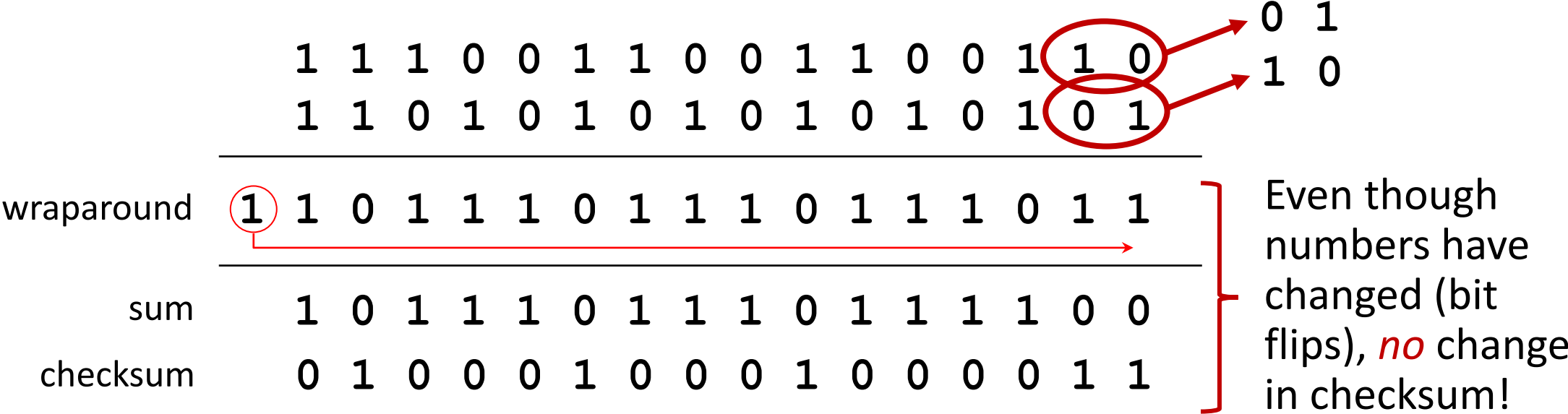

Summary: UDP

- “no frills” protocol:
 - segments may be lost, delivered out of order
 - best effort service: “send and hope for the best”
- UDP has its plusses:
 - no setup/handshaking needed (no RTT incurred)
 - can function when network service is compromised
 - helps with reliability (checksum)
- build additional functionality on top of UDP in application layer (e.g., HTTP/3)

Chapter 3: roadmap

- Transport-layer services
- Multiplexing and demultiplexing
- Connectionless transport: UDP
- **Principles of reliable data transfer**
- Connection-oriented transport: TCP
- Principles of congestion control
- TCP congestion control
- Evolution of transport-layer functionality



Principles of reliable data transfer



reliable service *abstraction*

Principles of reliable data transfer

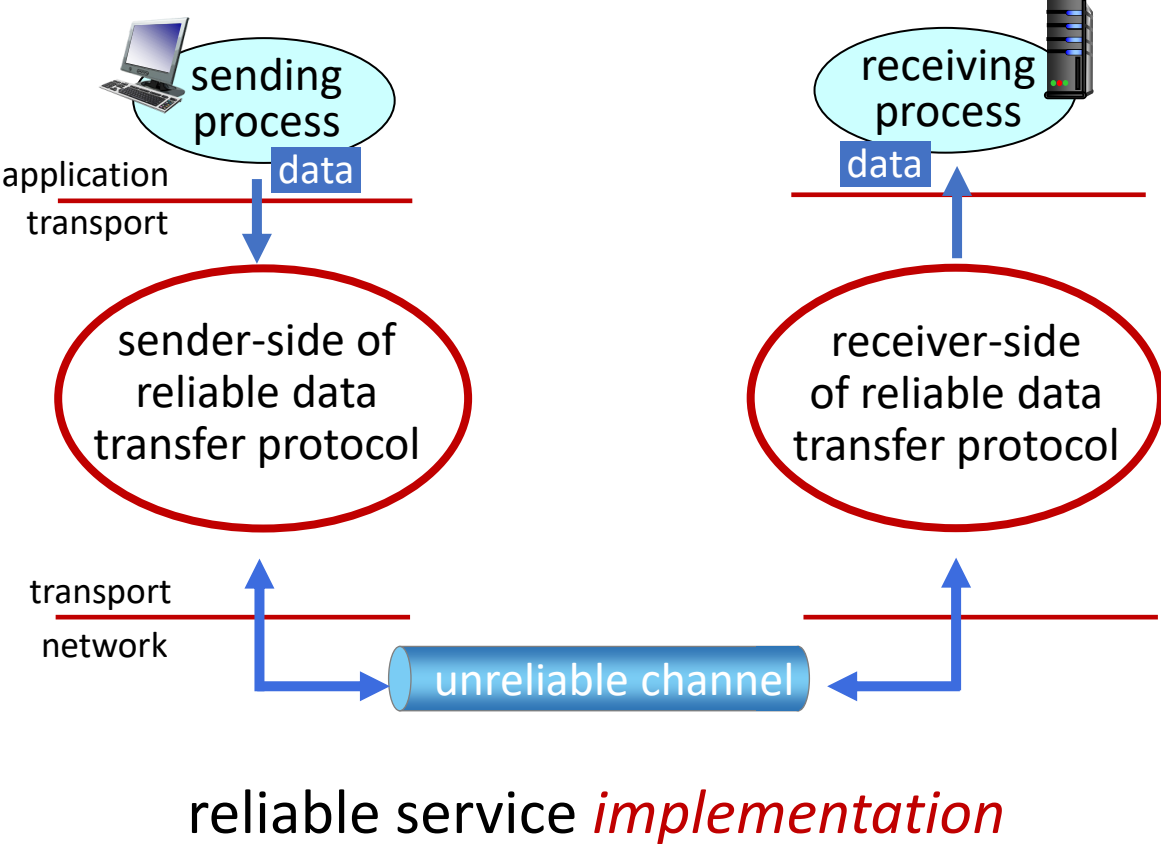
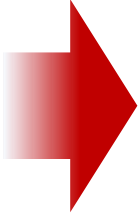
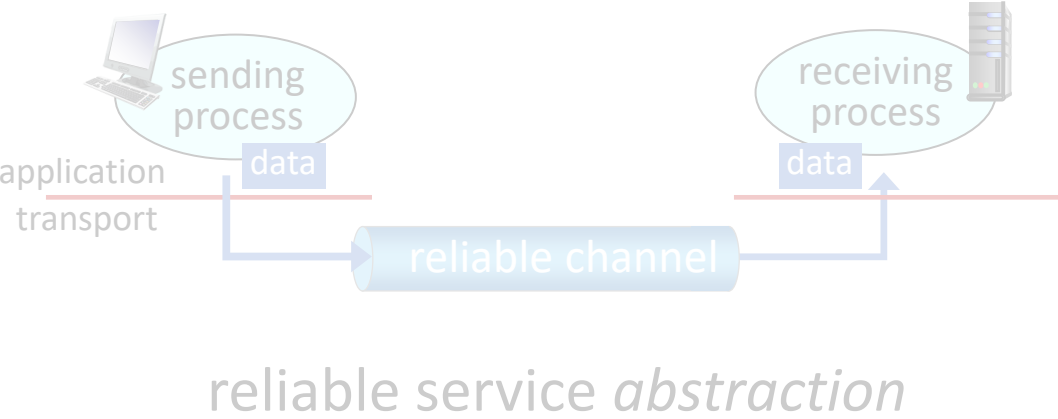

Principles of reliable data transfer

Complexity of reliable data transfer protocol will depend (strongly) on characteristics of unreliable channel (lose, corrupt, reorder data?)

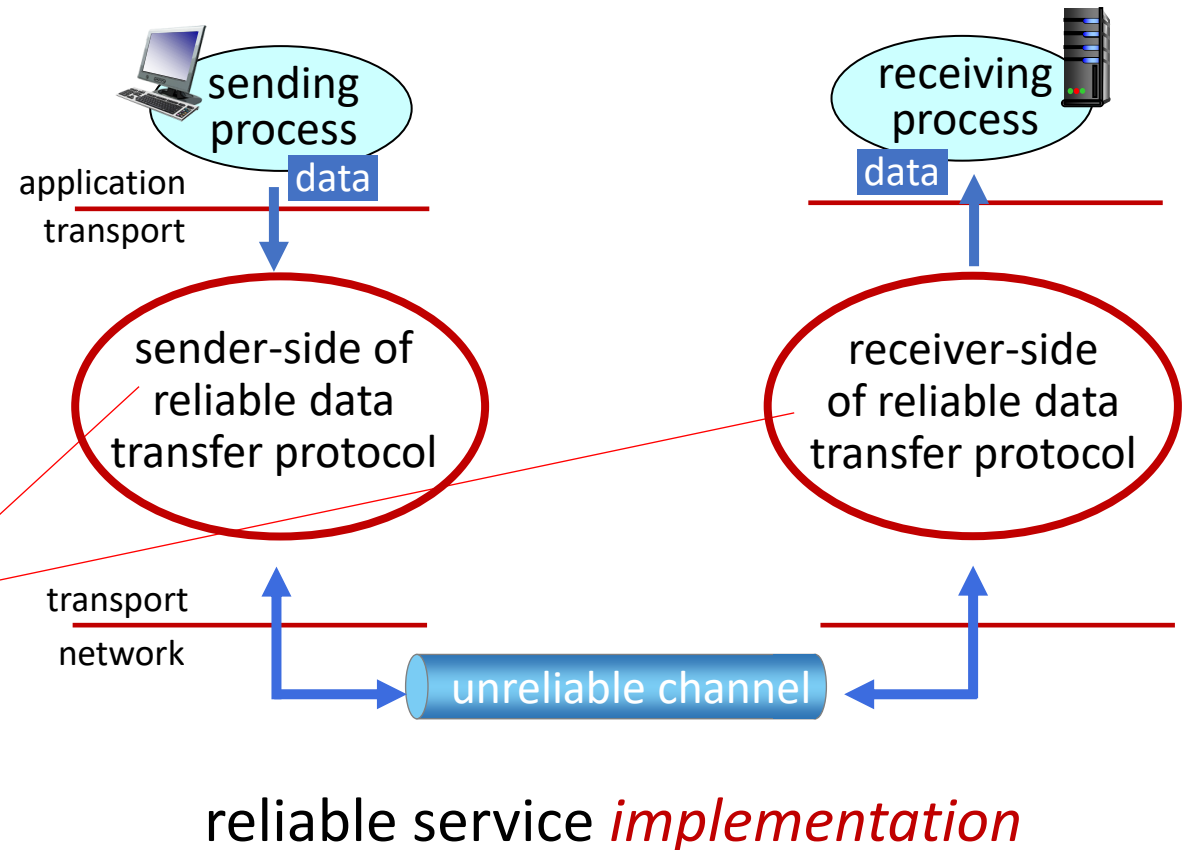

Principles of reliable data transfer

Sender, receiver do *not* know the “state” of each other, e.g., was a message received?

- unless communicated via a message

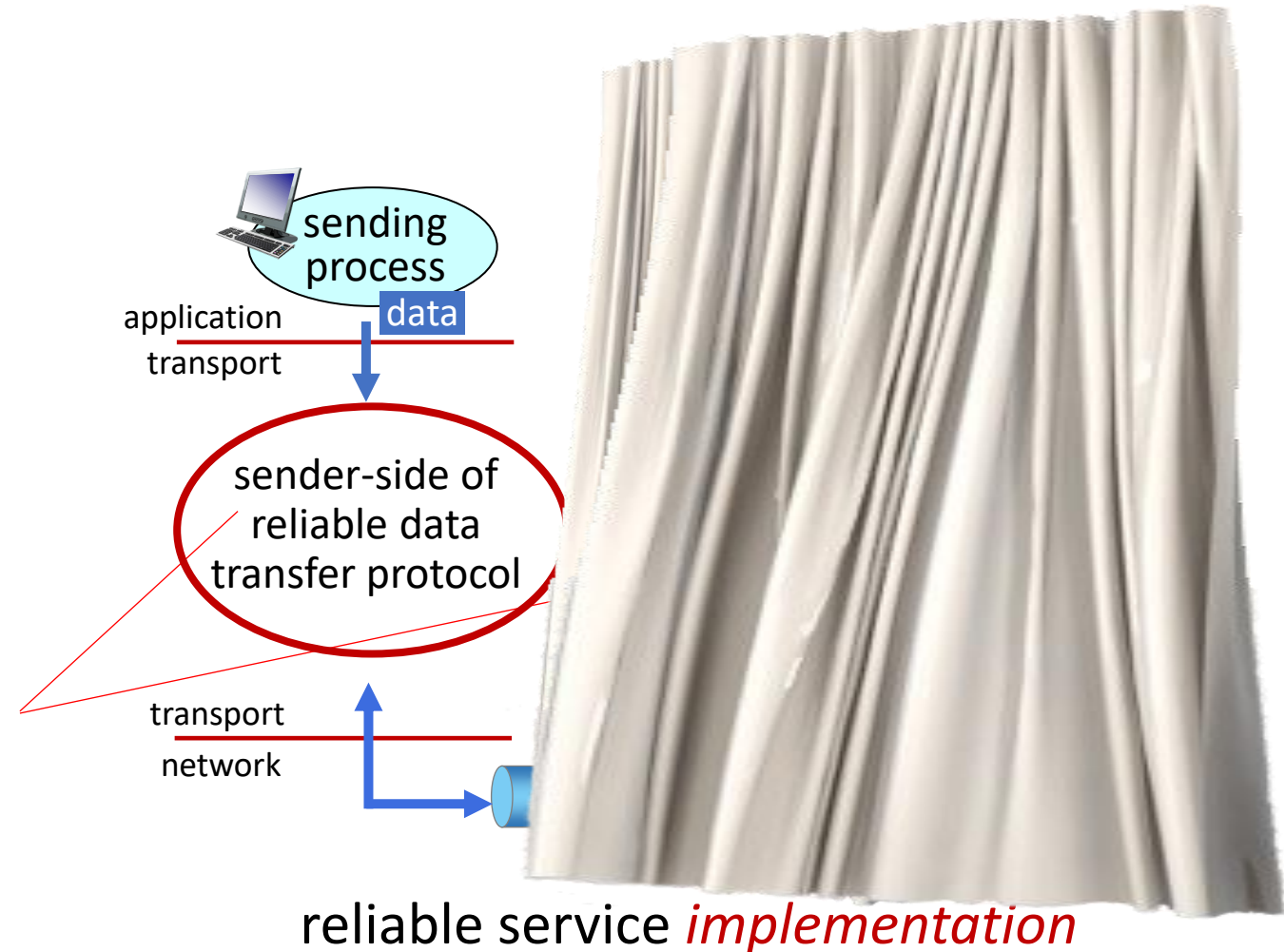

Reliable data transfer protocol (rdt): interfaces

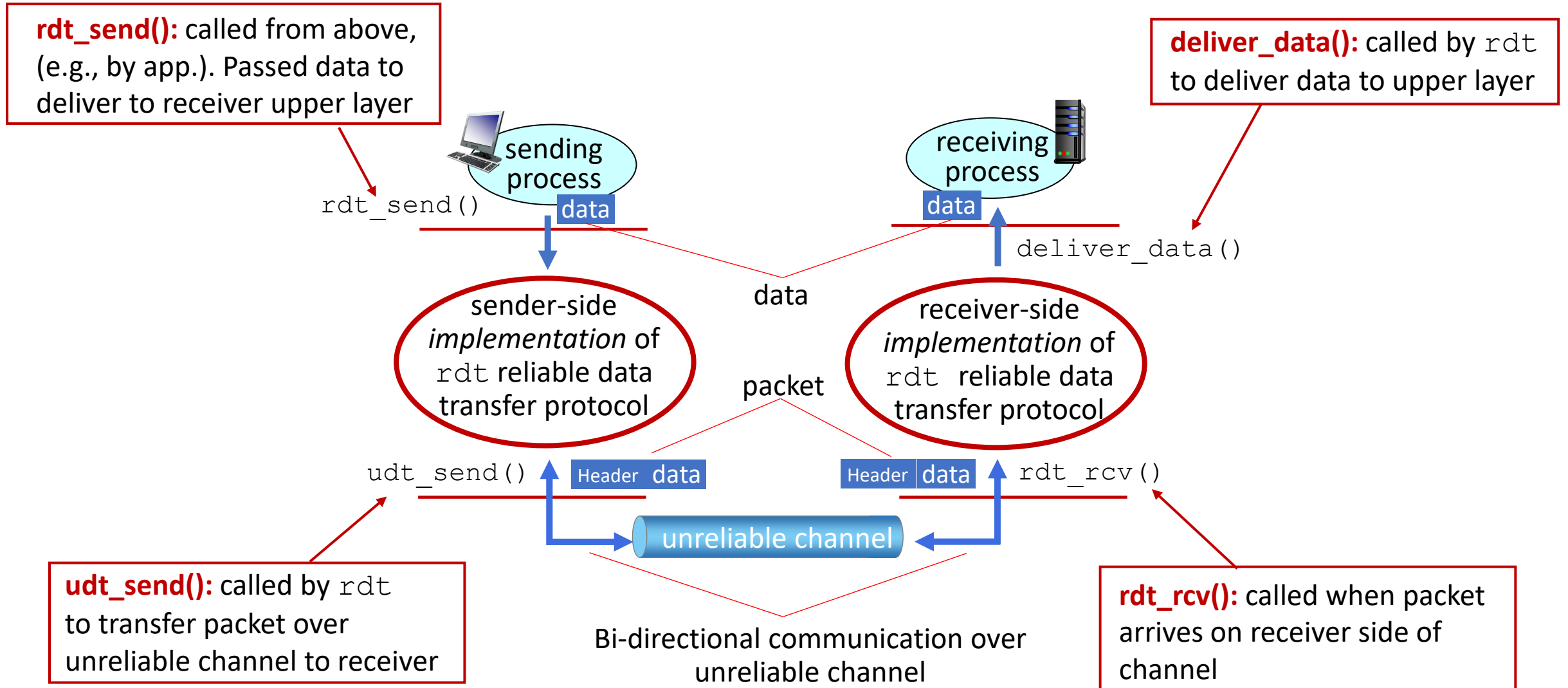

Reliable data transfer: getting started

We will:

- incrementally develop sender, receiver sides of reliable data transfer protocol (rdt)
- consider only unidirectional data transfer
 - but control info will flow in both directions!
- use finite state machines (FSM) to specify sender, receiver

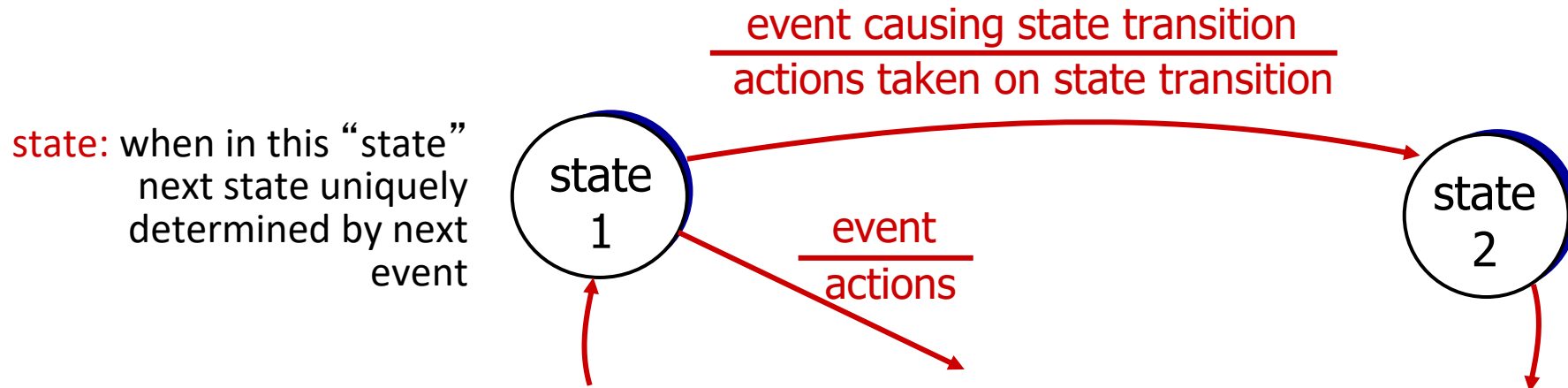

rdt1.0: reliable transfer over a reliable channel

- underlying channel perfectly reliable
 - no bit errors
 - no loss of packets
- *separate* FSMs for sender, receiver:
 - sender sends data into underlying channel
 - receiver reads data from underlying channel

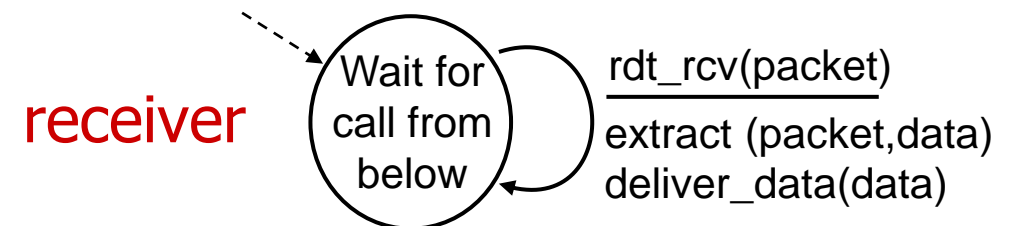
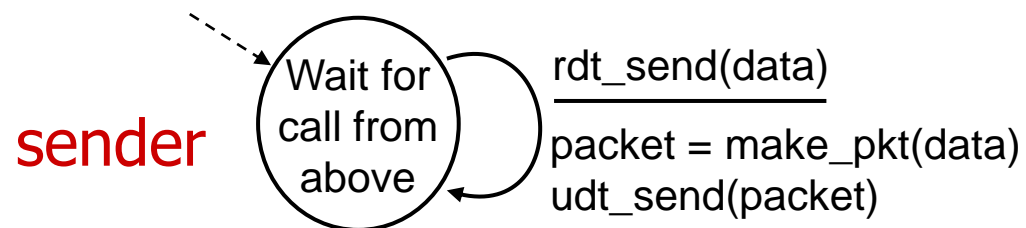

rdt2.0: channel with bit errors

- underlying channel may flip bits in packet
 - checksum (e.g., Internet checksum) to detect bit errors
- *the* question: how to recover from errors?

How do humans recover from “errors” during conversation?

rdt2.0: channel with bit errors

- underlying channel may flip bits in packet
 - checksum to detect bit errors
- *the* question: how to recover from errors?
 - *acknowledgements (ACKs)*: receiver explicitly tells sender that pkt received OK
 - *negative acknowledgements (NAKs)*: receiver explicitly tells sender that pkt had errors
 - sender *retransmits* pkt on receipt of NAK

stop and wait

sender sends one packet, then waits for receiver response

rdt2.0: FSM specifications

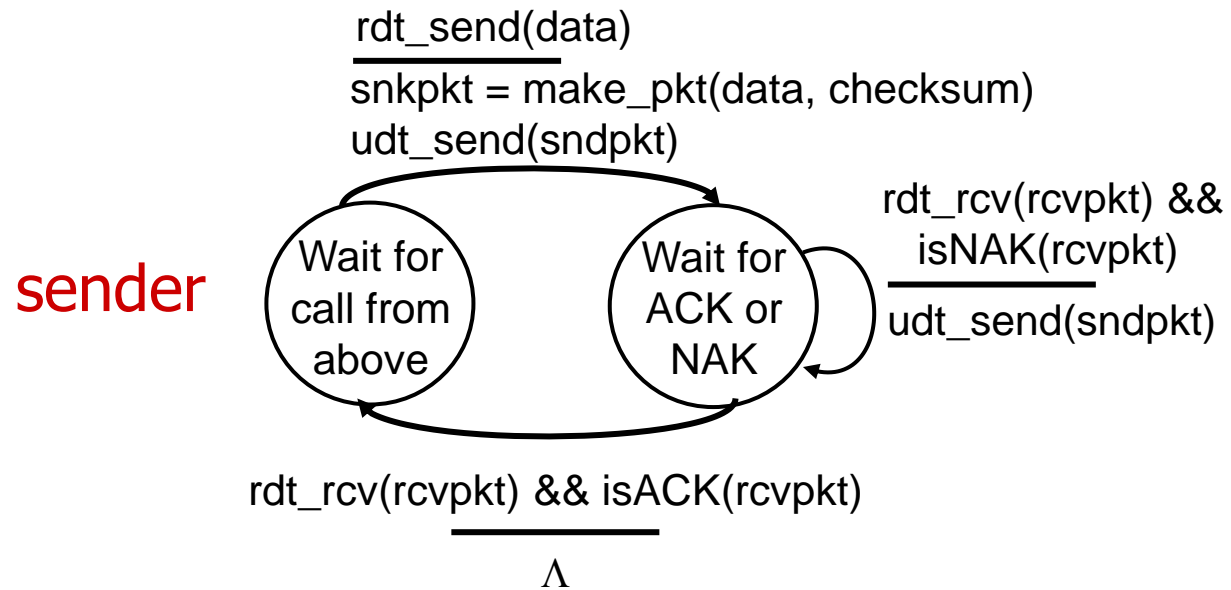

rdt2.0: FSM specification

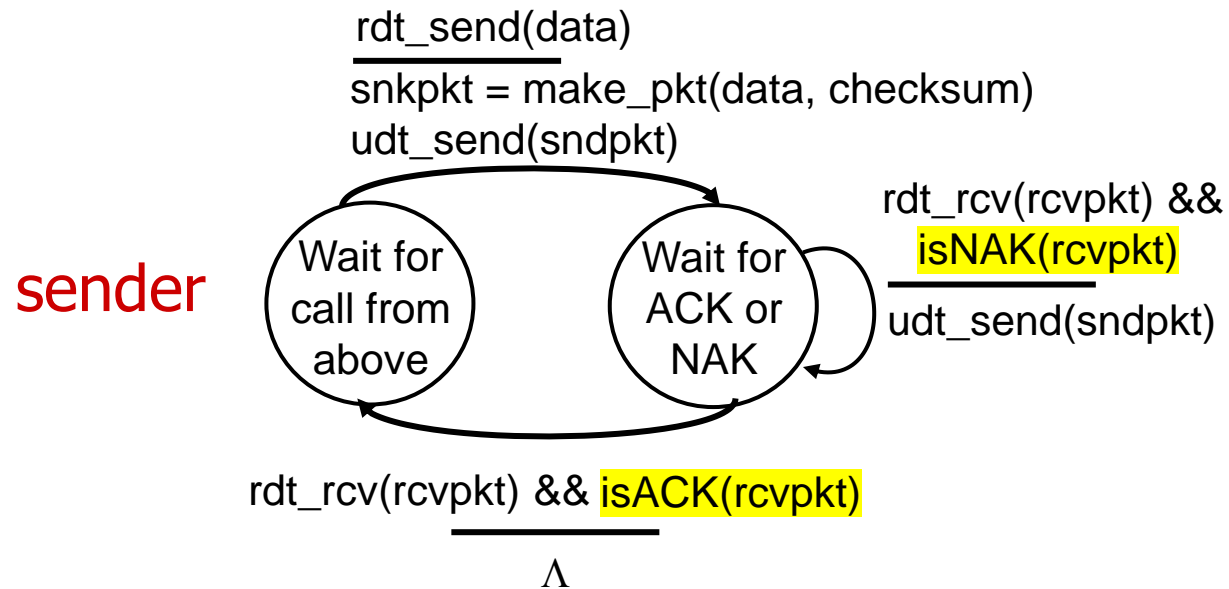

- Note:** “state” of receiver (did the receiver get my message correctly?) isn’t known to sender unless somehow communicated from receiver to sender
- that’s why we need a protocol!



rdt2.0: operation with no errors

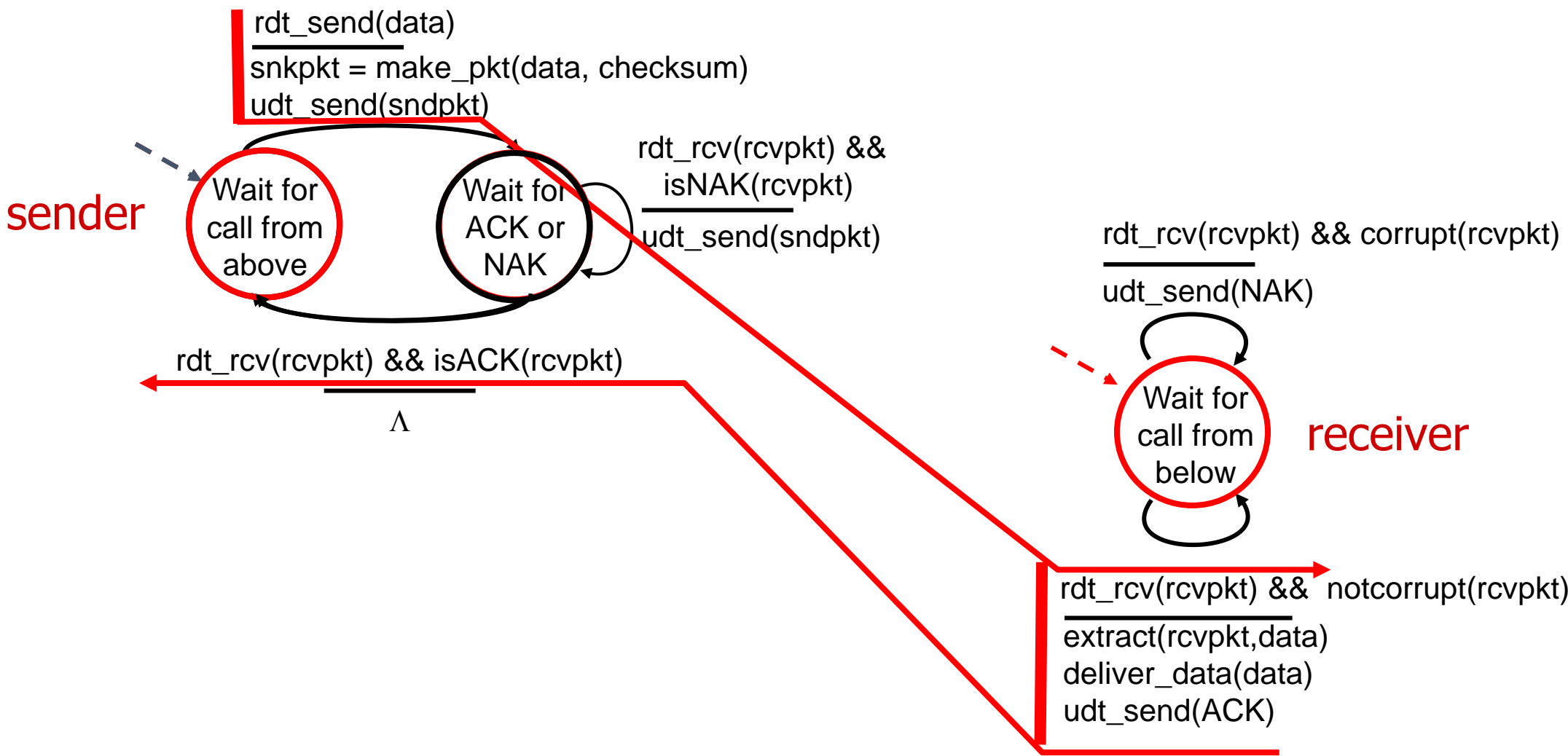

rdt2.0: corrupted packet scenario

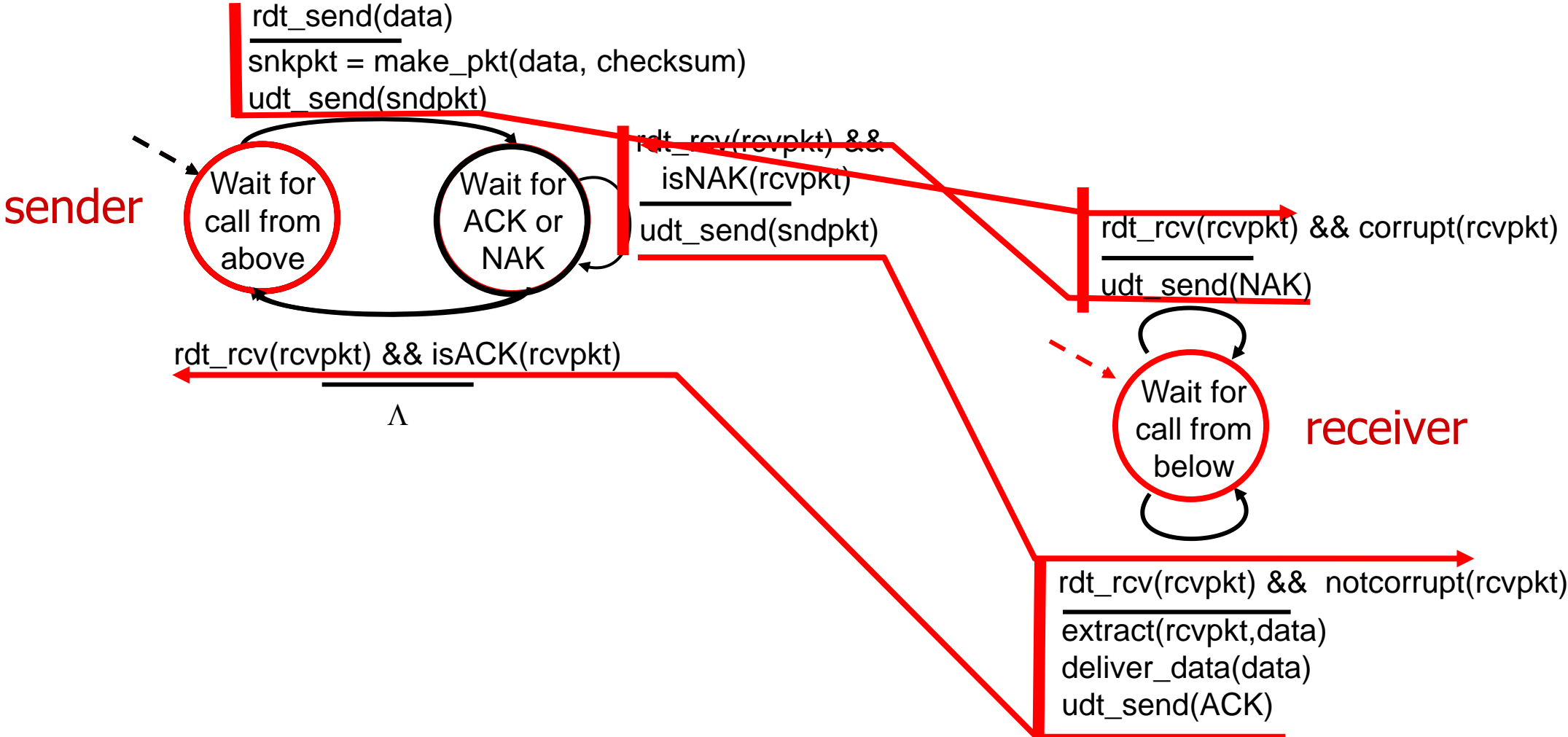

rdt2.0 has a fatal flaw!

what happens if ACK/NAK corrupted?

- sender doesn't know what happened at receiver!
- can't just retransmit: possible duplicate

handling duplicates:

- sender retransmits current pkt if ACK/NAK corrupted
- sender adds *sequence number* to each pkt
- receiver discards (doesn't deliver up) duplicate pkt

stop and wait

sender sends one packet, then waits for receiver response

rdt2.1: sender, handling garbled ACK/NAKs

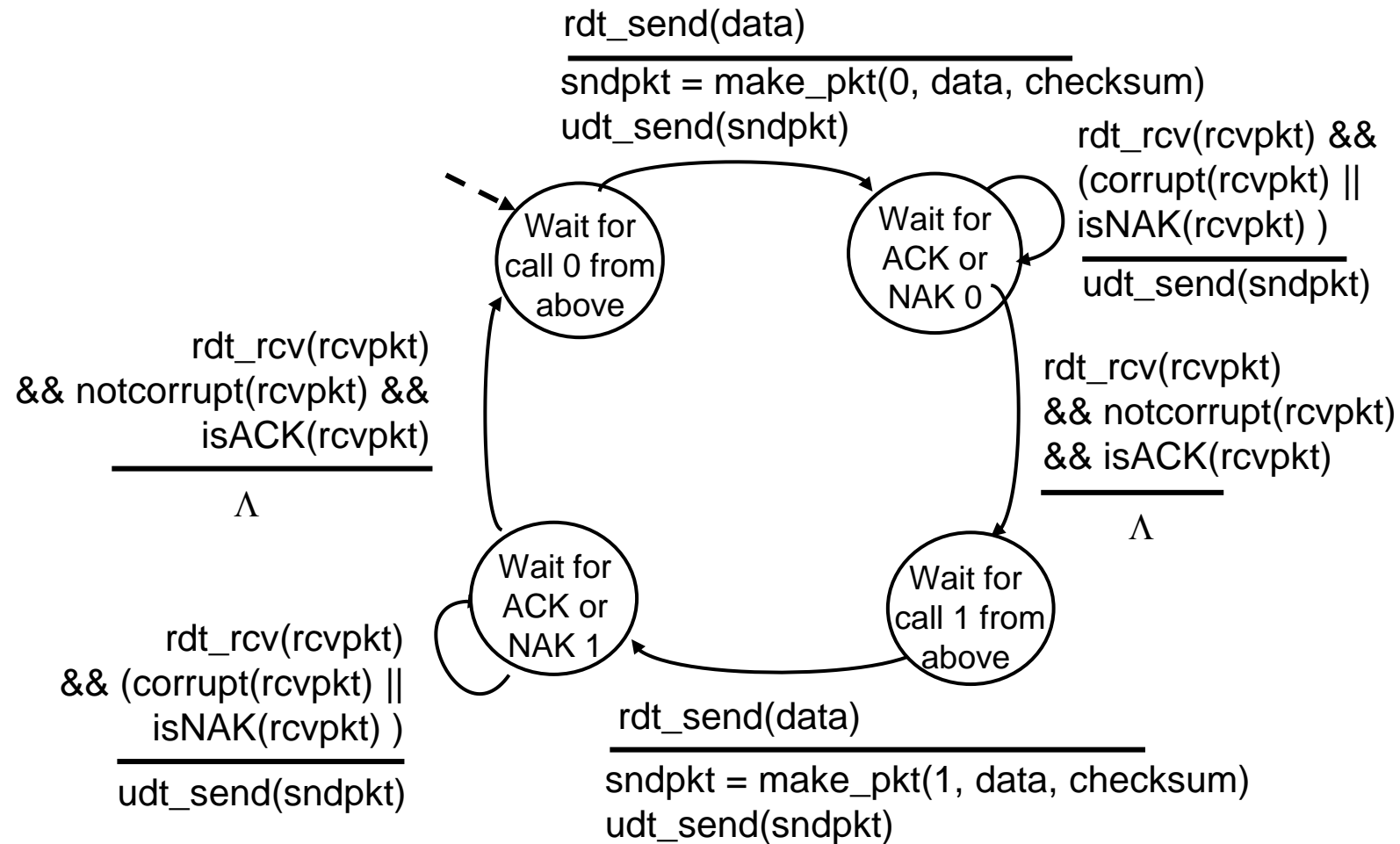

rdt2.1: receiver, handling garbled ACK/NAKs

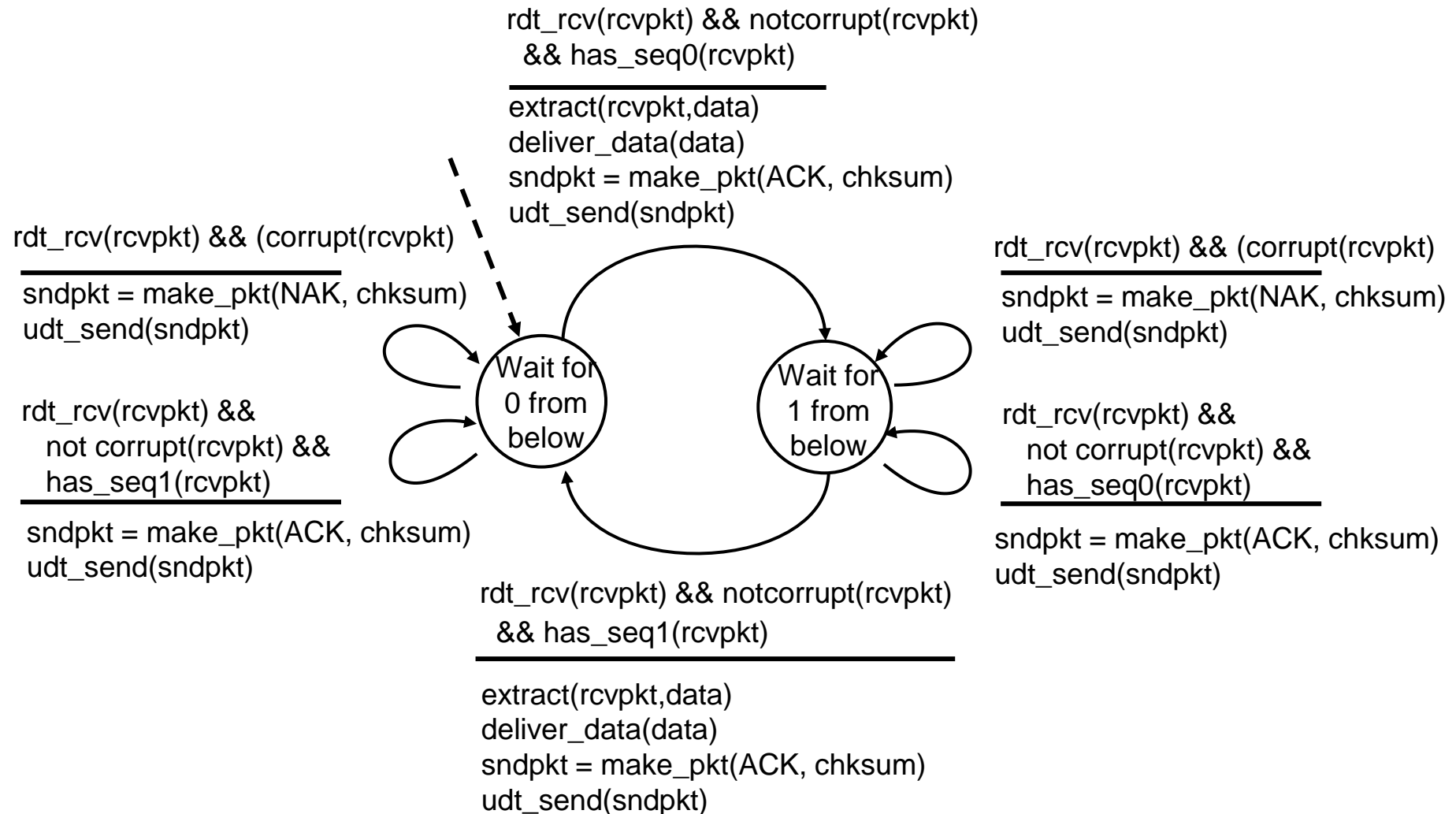

rdt2.1: discussion

sender:

- seq # added to pkt
- two seq. #s (0,1) will suffice.
Why?
- must check if received ACK/NAK corrupted
- twice as many states
 - state must “remember” whether “expected” pkt should have seq # of 0 or 1

receiver:

- must check if received packet is duplicate
 - state indicates whether 0 or 1 is expected pkt seq #
- note: receiver can *not* know if its last ACK/NAK received OK at sender

rdt2.2: a NAK-free protocol

- same functionality as rdt2.1, using ACKs only
- instead of NAK, receiver sends ACK for last pkt received OK
 - receiver must *explicitly* include seq # of pkt being ACKed
- duplicate ACK at sender results in same action as NAK:
retransmit current pkt

As we will see, TCP uses this approach to be NAK-free

rdt2.2: sender, receiver fragments

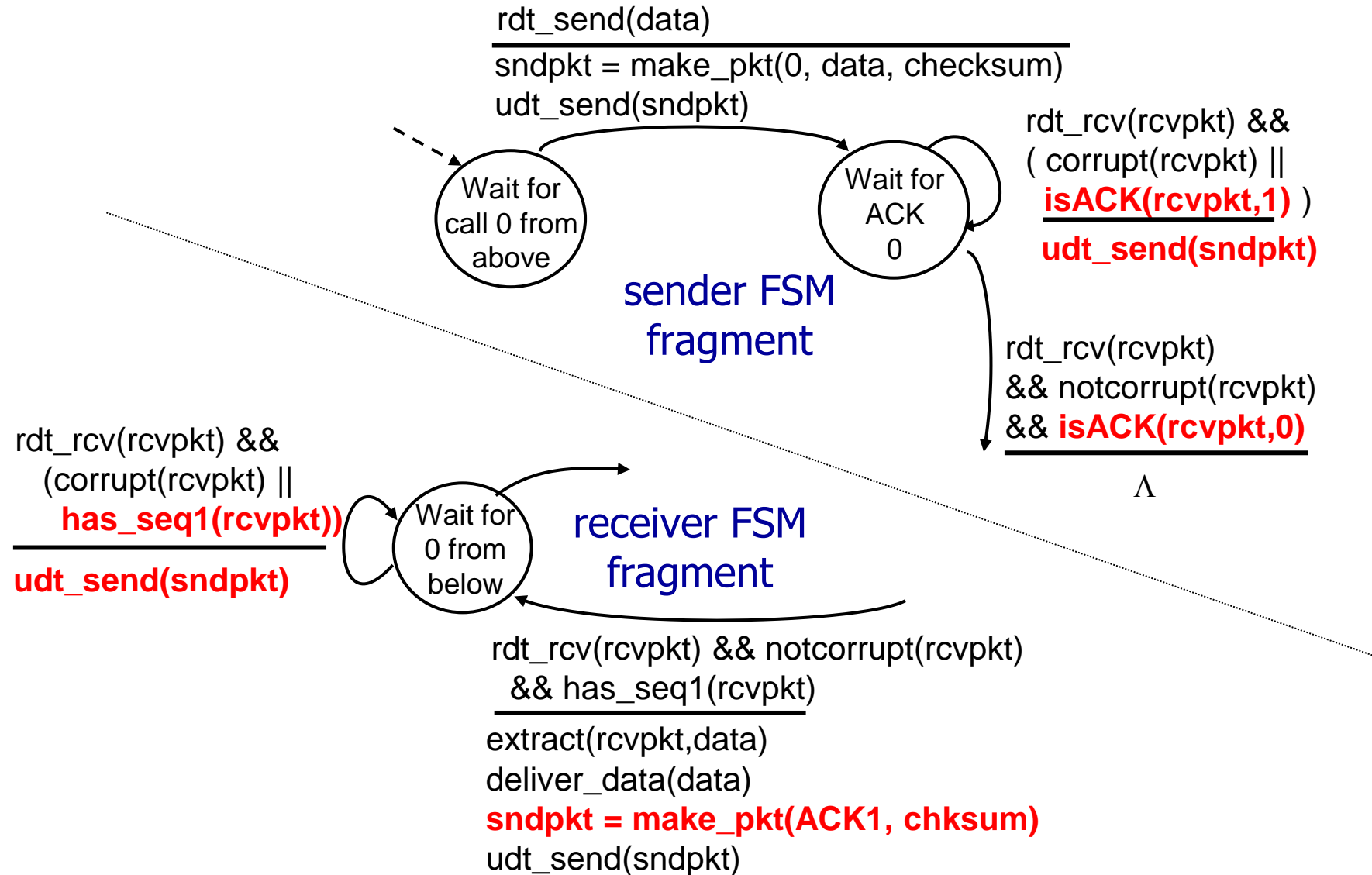

rdt3.0: channels with errors *and* loss

New channel assumption: underlying channel can also *lose* packets (data, ACKs)

- checksum, sequence #s, ACKs, retransmissions will be of help ... but not quite enough

Q: How do *humans* handle lost sender-to-receiver words in conversation?

rdt3.0: channels with errors *and* loss

Approach: sender waits “reasonable” amount of time for ACK

- retransmits if no ACK received in this time
- if pkt (or ACK) just delayed (not lost):
 - retransmission will be duplicate, but seq #s already handles this!
 - receiver must specify seq # of packet being ACKed
- use countdown timer to interrupt after “reasonable” amount of time



timeout

rdt3.0 sender

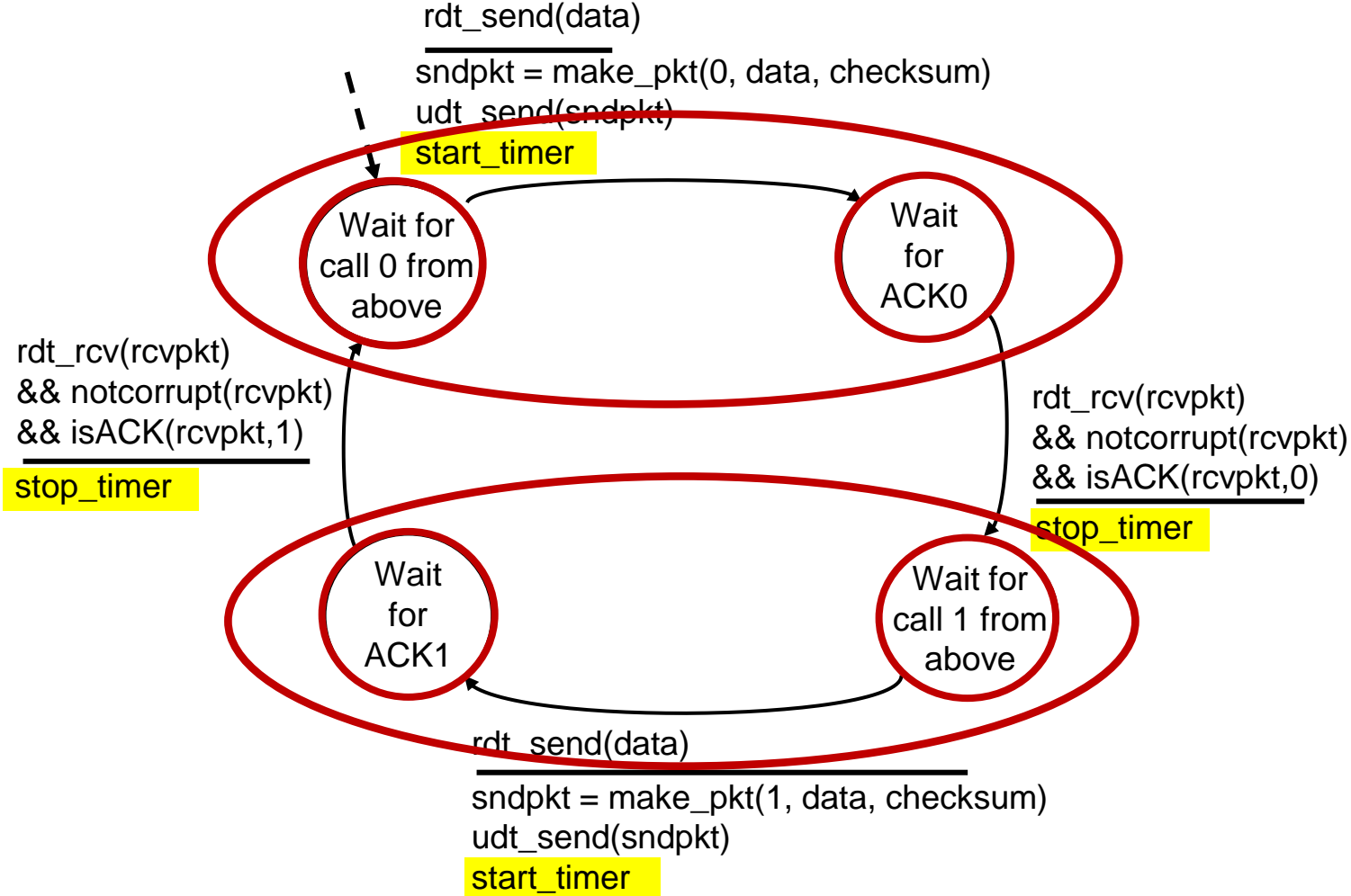

rdt3.0 sender

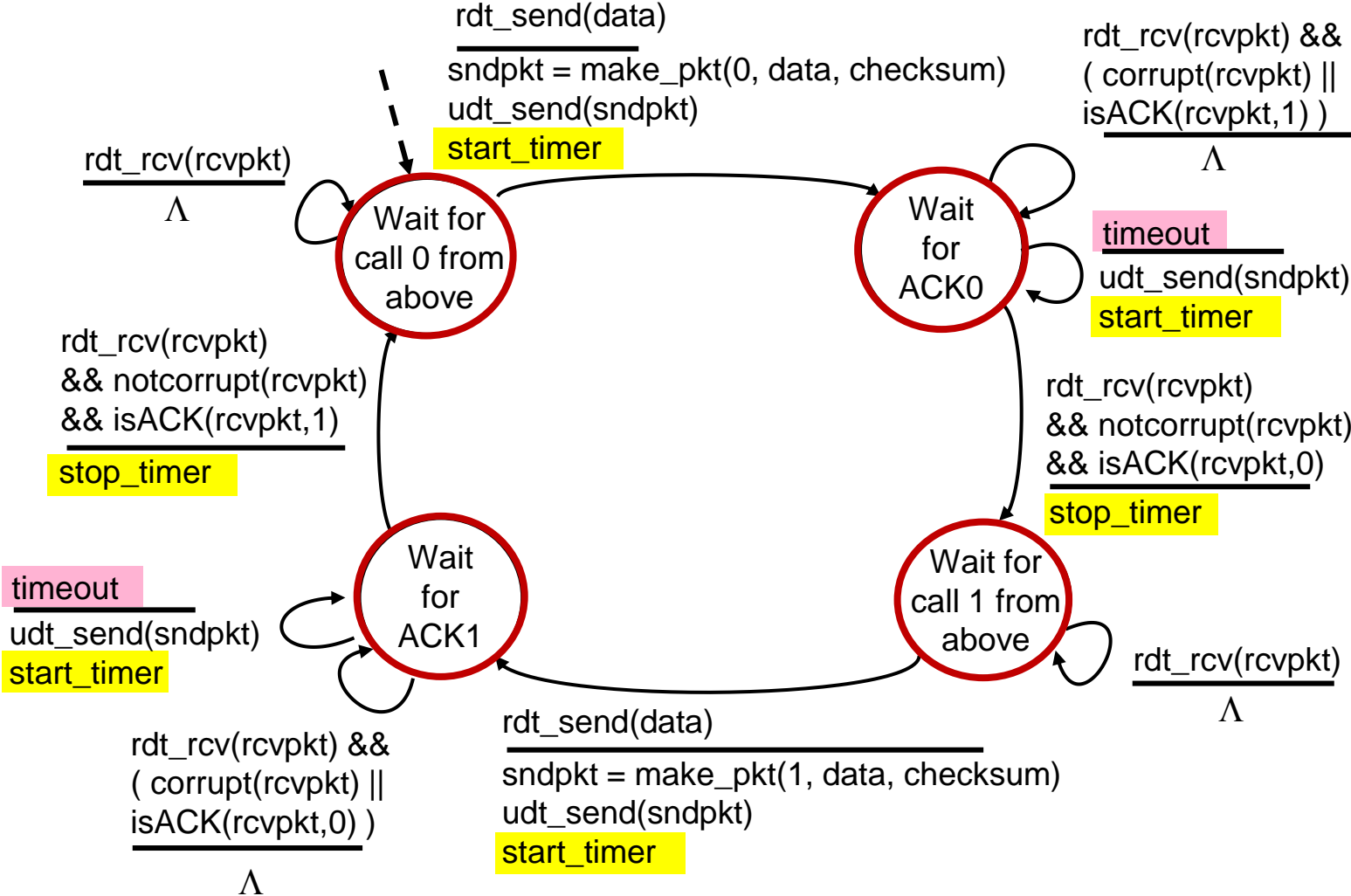

rdt3.0 in action

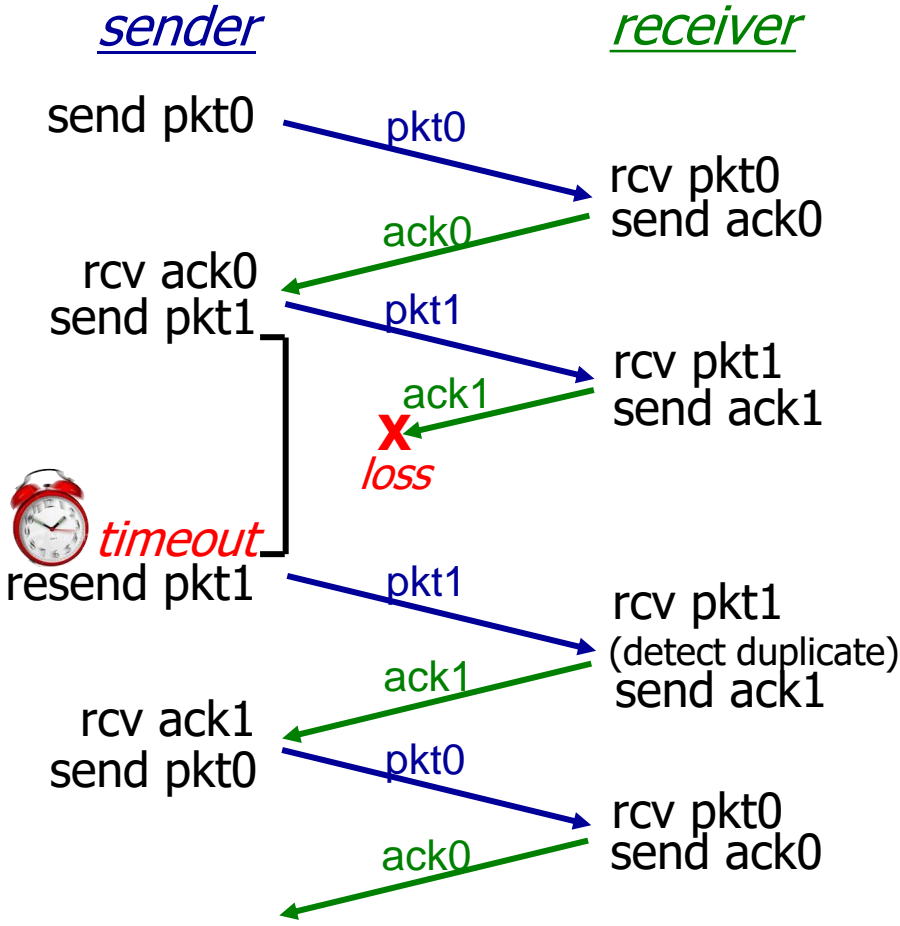

(c) ACK loss

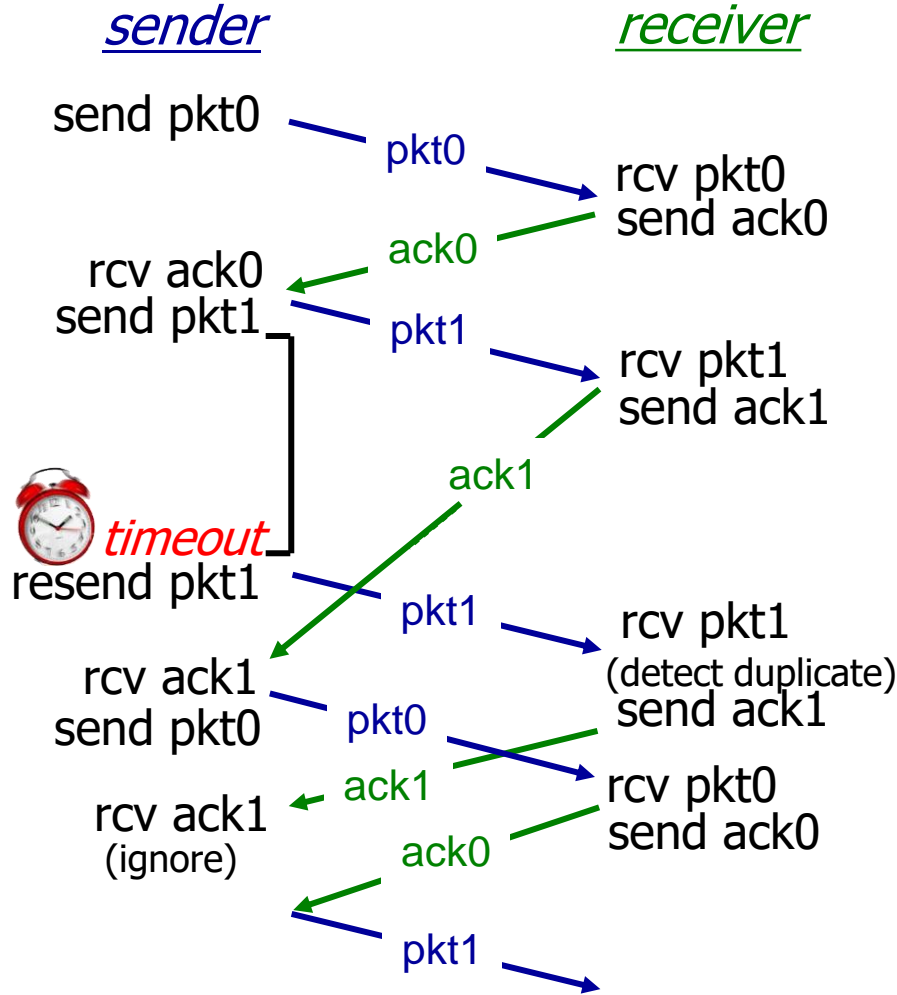

(d) premature timeout/ delayed ACK

Performance of rdt3.0 (stop-and-wait)

- U_{sender} : *utilization* – fraction of time sender busy sending
- example: 1 Gbps link, 15 ms prop. delay, 8000 bit packet
 - time to transmit packet into channel:

$$D_{trans} = \frac{L}{R} = \frac{8000 \text{ bits}}{10^9 \text{ bits/sec}} = 8 \text{ microsecs}$$

rdt3.0: stop-and-wait operation

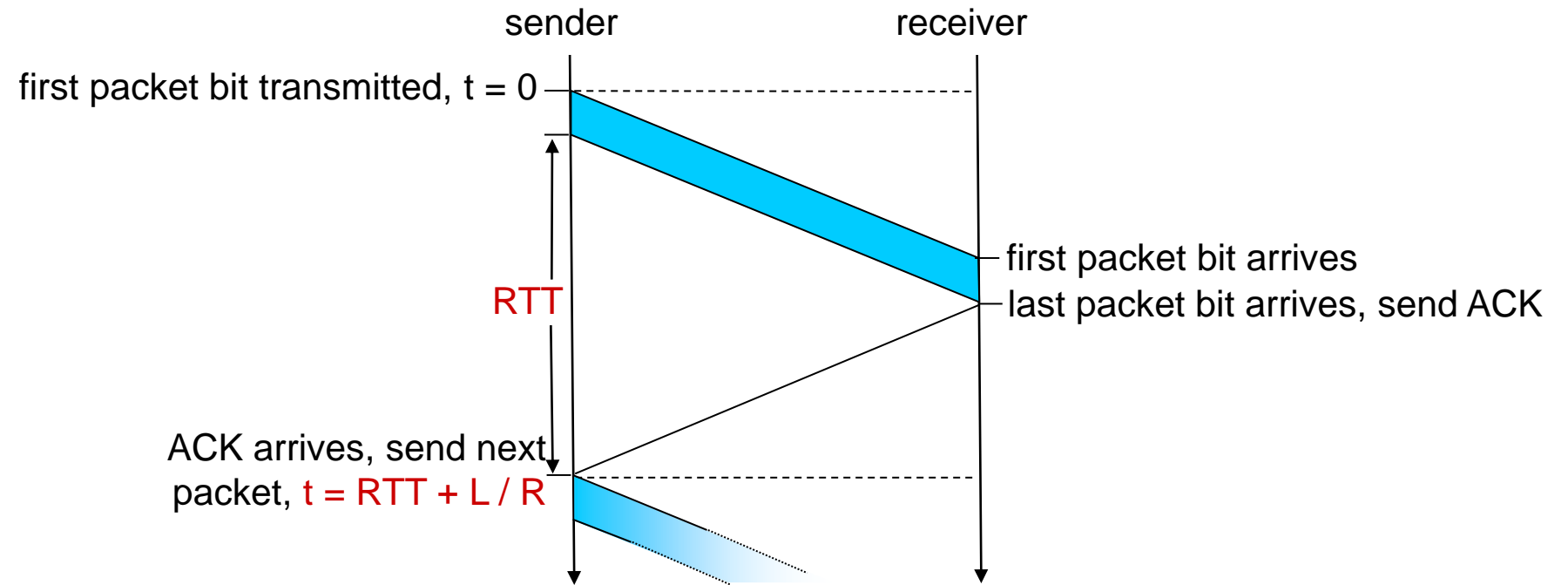

rdt3.0: stop-and-wait operation

$$\begin{aligned} U_{\text{sender}} &= \frac{L / R}{RTT + L / R} \\ &= \frac{.008}{30.008} \\ &= 0.00027 \end{aligned}$$

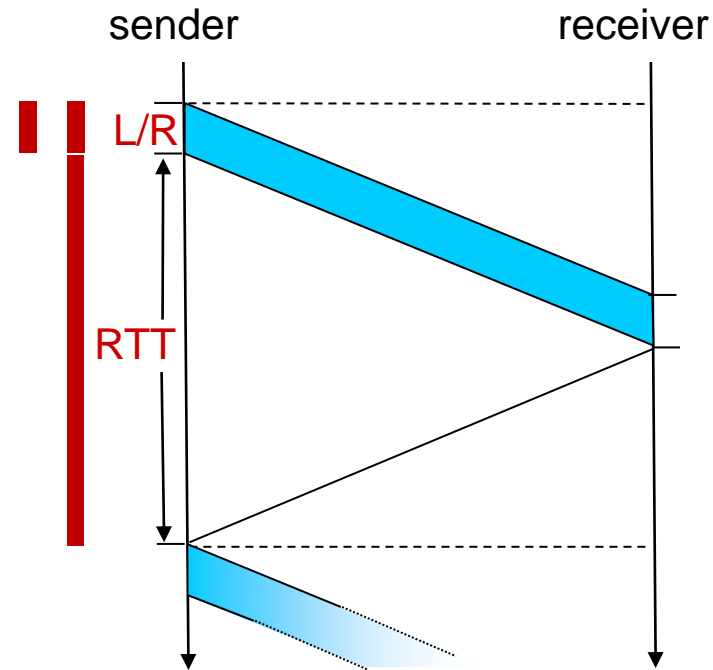

- rdt 3.0 protocol performance stinks!
- Protocol limits performance of underlying infrastructure (channel)

rdt3.0: pipelined protocols operation

pipelining: sender allows multiple, “in-flight”, yet-to-be-acknowledged packets

- range of sequence numbers must be increased
- buffering at sender and/or receiver

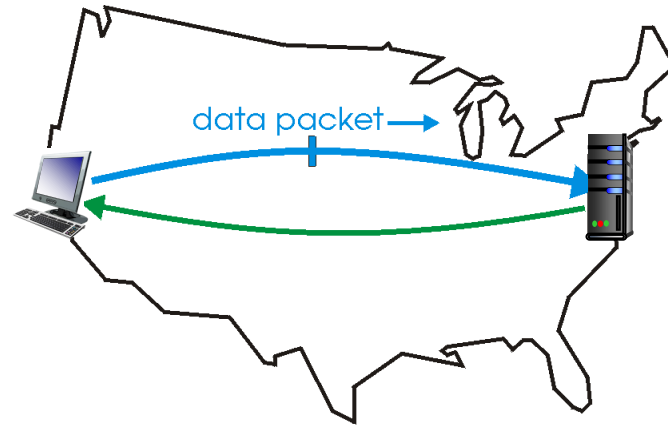

(a) a stop-and-wait protocol in operation

Pipelining: increased utilization

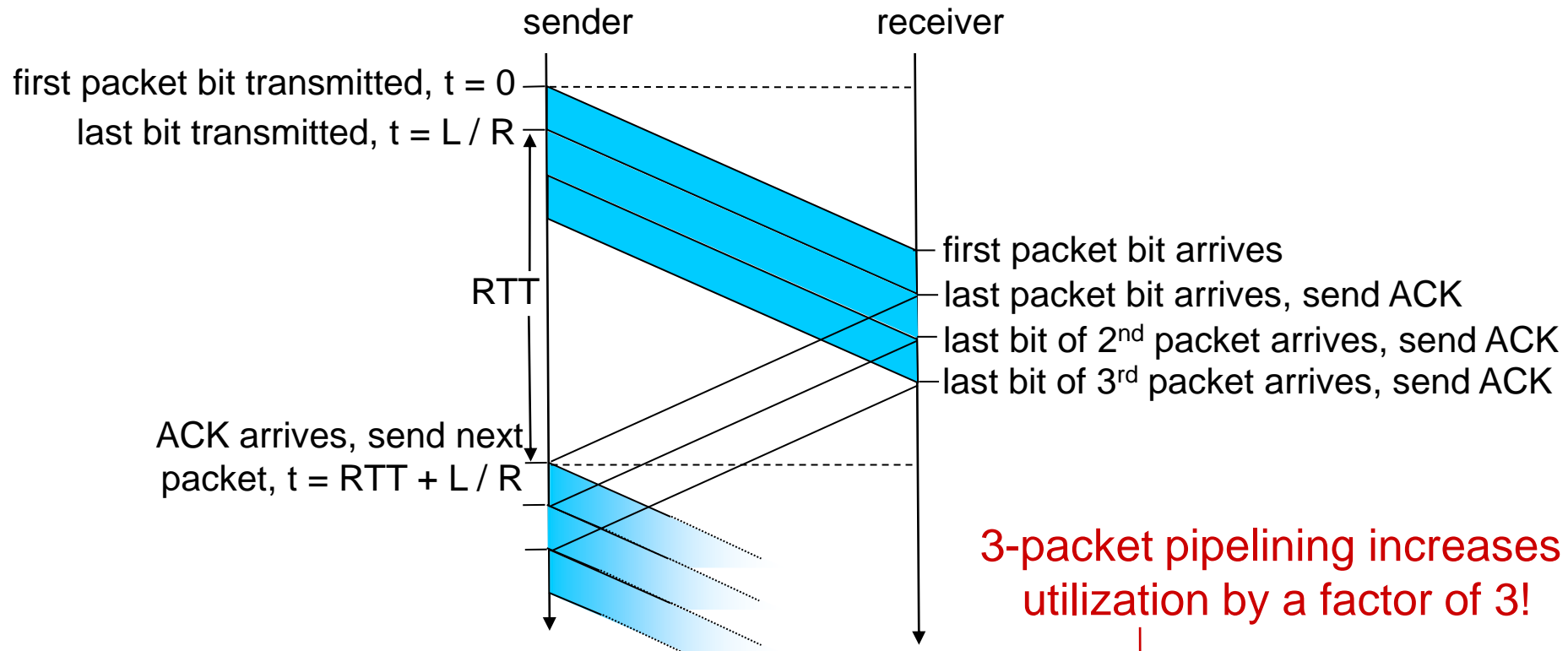

3-packet pipelining increases utilization by a factor of 3!

$$U_{sender} = \frac{3L / R}{RTT + L / R} = \frac{.0024}{30.008} = 0.00081$$

Go-Back-N: sender

- sender: “window” of up to N , consecutive transmitted but unACKed pkts
 - k -bit seq # in pkt header

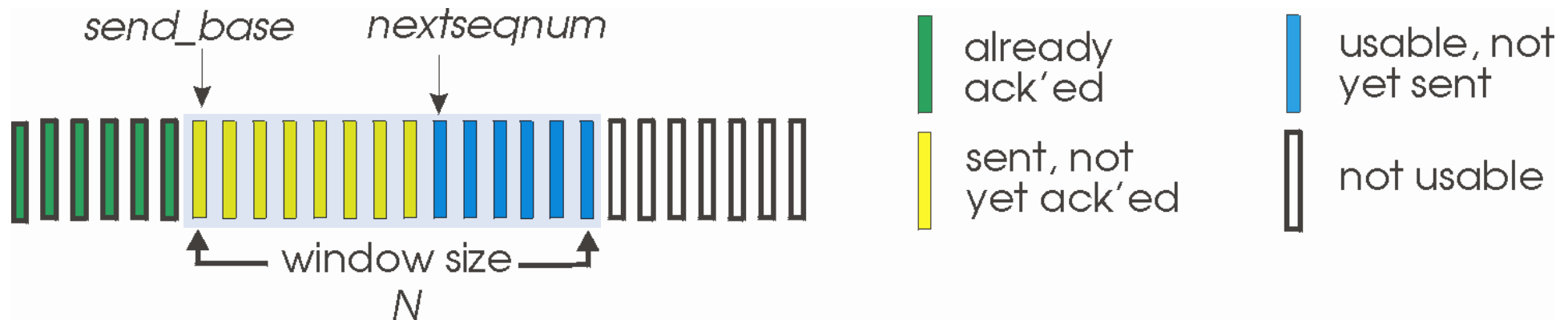

- ***cumulative ACK***: $ACK(n)$: ACKs all packets up to, including seq # n
 - on receiving $ACK(n)$: move window forward to begin at $n+1$
- timer for oldest in-flight packet
- ***timeout(n)***: retransmit packet n and all higher seq # packets in window

Go-Back-N: receiver

- ACK-only: always send ACK for correctly-received packet so far, with highest *in-order* seq #
 - may generate duplicate ACKs
 - need only remember `rcv_base`
- on receipt of out-of-order packet:
 - can discard (don't buffer) or buffer: an implementation decision
 - re-ACK pkt with highest in-order seq #

Receiver view of sequence number space:



Go-Back-N in action

sender window (N=4)

0 1 2 3 4 5 6 7 8
 0 1 2 3 4 5 6 7 8
 0 1 2 3 4 5 6 7 8
 0 1 2 3 4 5 6 7 8

0 1 2 3 4 5 6 7 8
 0 1 2 3 4 5 6 7 8

0 1 2 3 4 5 6 7 8
 0 1 2 3 4 5 6 7 8
 0 1 2 3 4 5 6 7 8
 0 1 2 3 4 5 6 7 8

sender

send pkt0
 send pkt1
 send pkt2
 send pkt3
 (wait)

rcv ack0, send pkt4
 rcv ack1, send pkt5

ignore duplicate ACK

 *pkt 2 timeout*

send pkt2
 send pkt3
 send pkt4
 send pkt5

receiver

receive pkt0, send ack0
 receive pkt1, send ack1
 receive pkt3, discard,
 (re)send ack1
 receive pkt4, discard,
 (re)send ack1
 receive pkt5, discard,
 (re)send ack1

rcv pkt2, deliver, send ack2
 rcv pkt3, deliver, send ack3
 rcv pkt4, deliver, send ack4
 rcv pkt5, deliver, send ack5

X loss

Selective repeat

- receiver *individually* acknowledges all correctly received packets
 - buffers packets, as needed, for eventual in-order delivery to upper layer
- sender times-out/retransmits individually for unACKed packets
 - sender maintains timer for each unACKed pkt
- sender window
 - N consecutive seq #s
 - limits seq #s of sent, unACKed packets

Selective repeat: sender, receiver windows

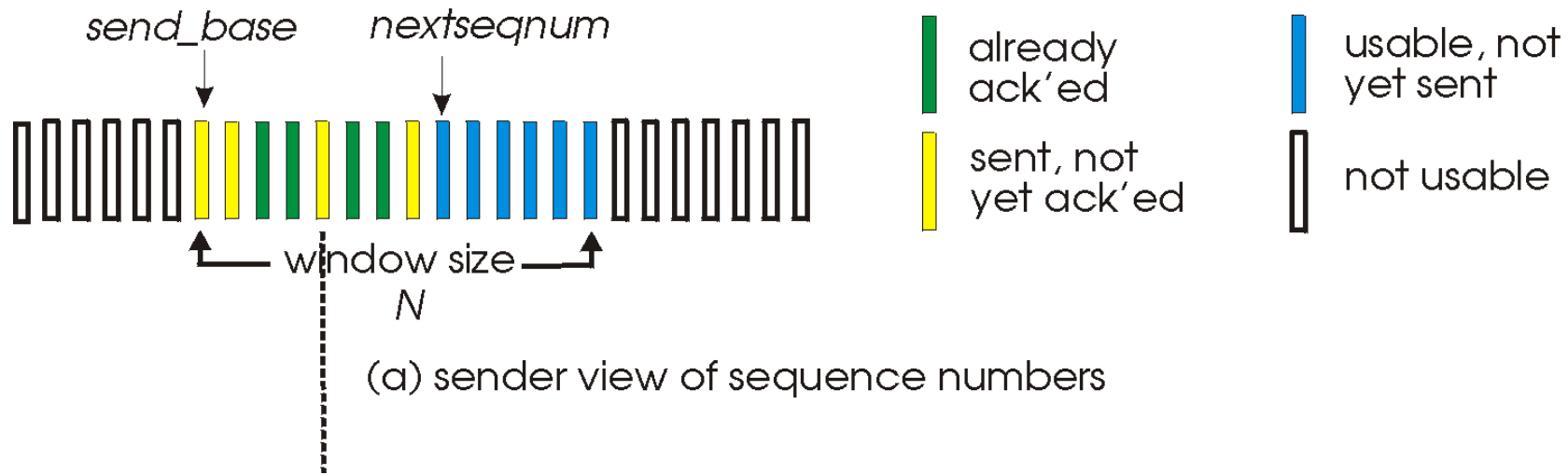

Selective repeat: sender and receiver

sender

data from above:

- if next available seq # in window, send packet

timeout(n):

- resend packet n , restart timer

ACK(n) in [sendbase,sendbase+N]:

- mark packet n as received
- if n smallest unACKed packet, advance window base to next unACKed seq #

receiver

packet n in [rcvbase, rcvbase+N-1]

- send ACK(n)
- out-of-order: buffer
- in-order: deliver (also deliver buffered, in-order packets), advance window to next not-yet-received packet

packet n in [rcvbase-N,rcvbase-1]

- ACK(n)

otherwise:

- ignore

Selective Repeat in action

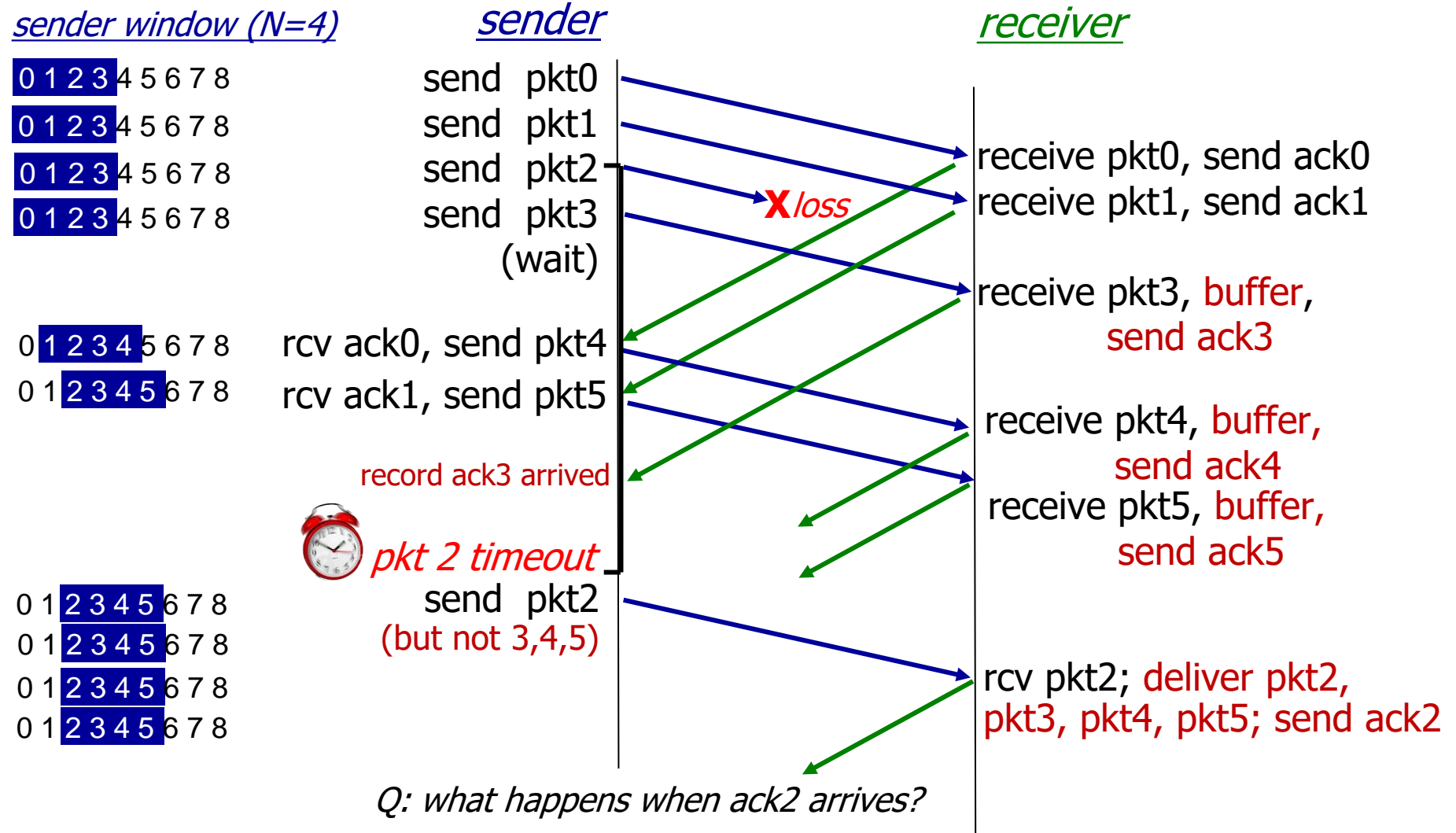

Selective repeat: a dilemma!

example:

- seq #s: 0, 1, 2, 3 (base 4 counting)
- window size=3

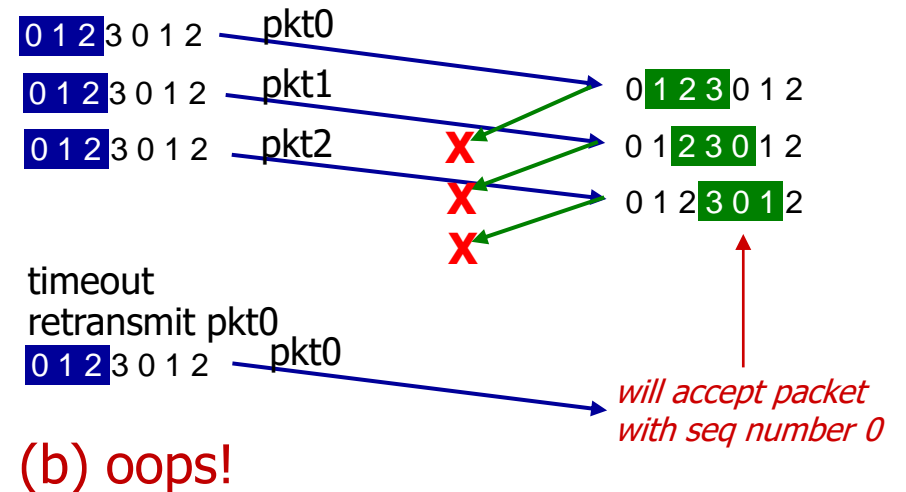
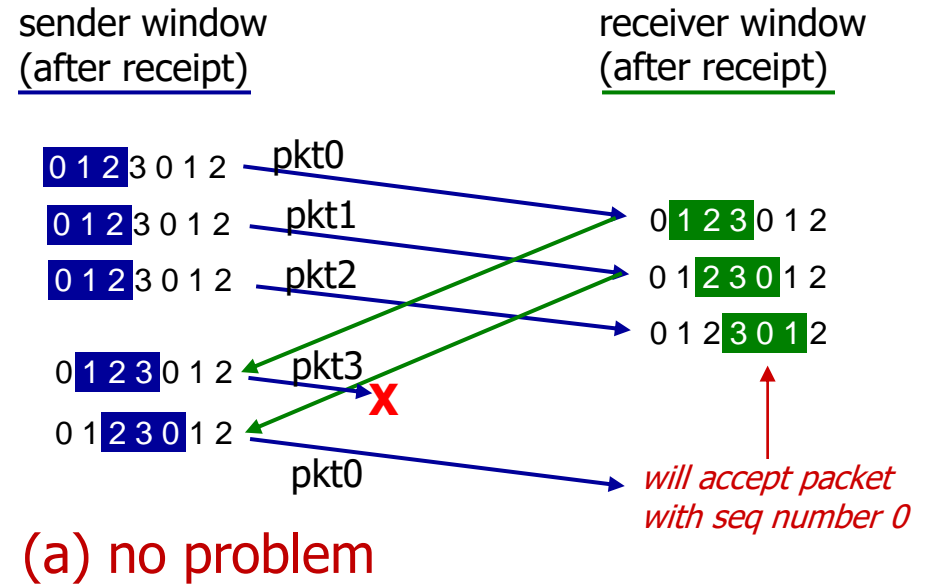

Selective repeat: a dilemma!

example:

- seq #s: 0, 1, 2, 3 (base 4 counting)
- window size=3

Q: what relationship is needed between sequence # size and window size to avoid problem in scenario (b)?

sender window
(after receipt)

receiver window
(after receipt)

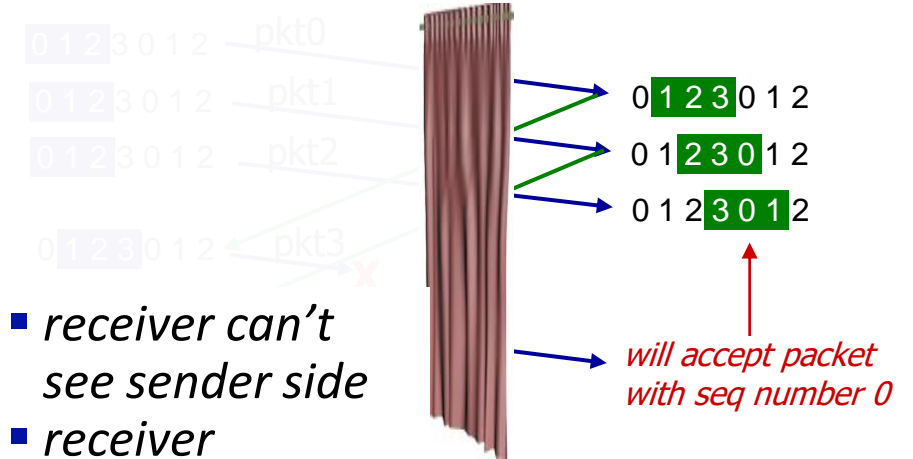

- receiver can't see sender side
- receiver behavior identical in both cases!

▪ **something's (very) wrong!**

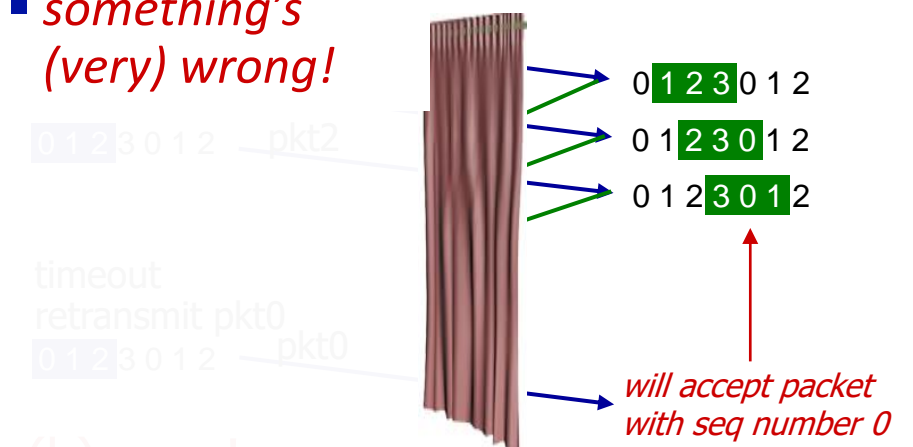

(b) oops!

Chapter 3: roadmap

- Transport-layer services
- Multiplexing and demultiplexing
- Connectionless transport: UDP
- Principles of reliable data transfer
- **Connection-oriented transport: TCP**
 - segment structure
 - reliable data transfer
 - flow control
 - connection management
- Principles of congestion control
- TCP congestion control



TCP: overview

RFCs: 793,1122, 2018, 5681, 7323

- **point-to-point:**
 - one sender, one receiver
- **reliable, in-order *byte stream*:**
 - no “message boundaries”
- **full duplex data:**
 - bi-directional data flow in same connection
 - MSS: maximum segment size
- **cumulative ACKs**
- **pipelining:**
 - TCP congestion and flow control set window size
- **connection-oriented:**
 - handshaking (exchange of control messages) initializes sender, receiver state before data exchange
- **flow controlled:**
 - sender will not overwhelm receiver

TCP segment structure

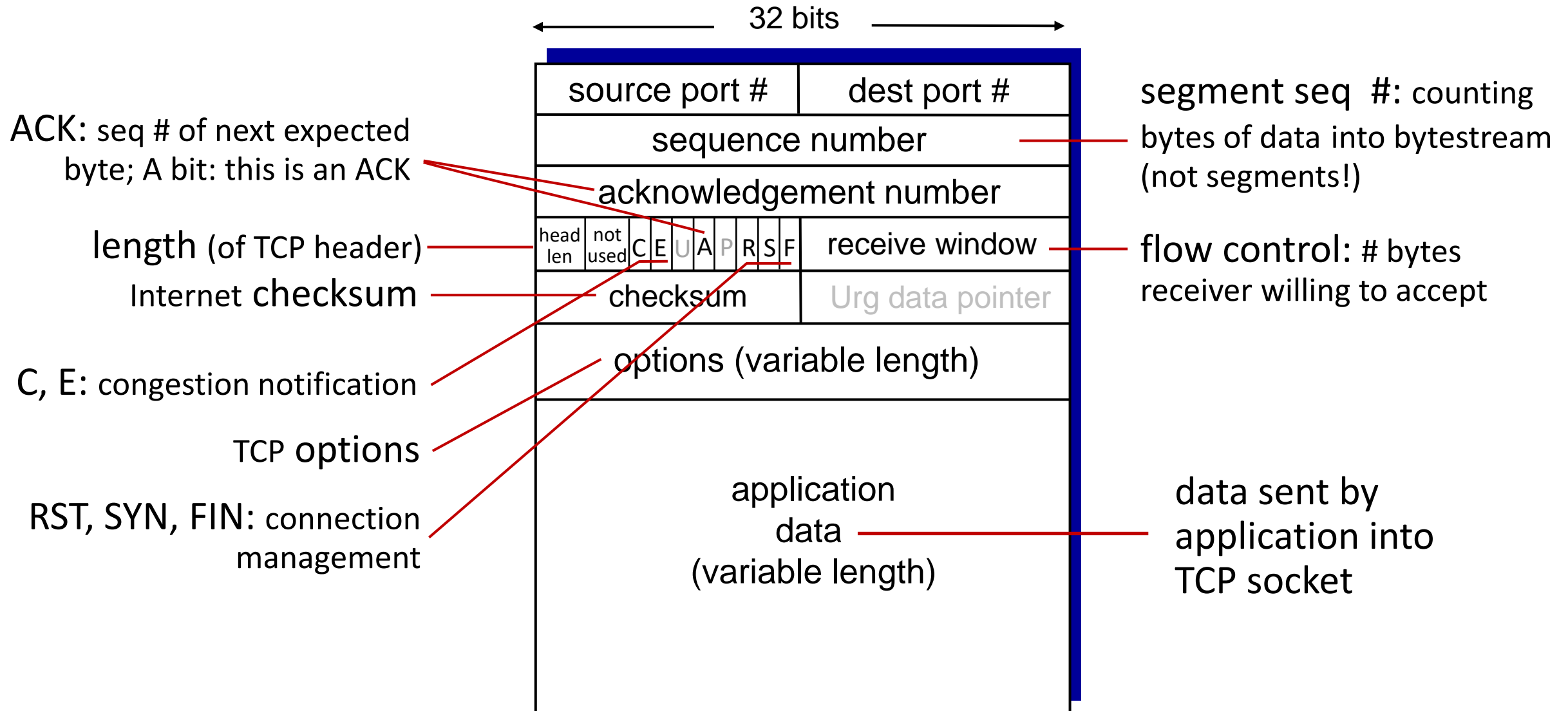

TCP sequence numbers, ACKs

Sequence numbers:

- byte stream “number” of first byte in segment’s data

Acknowledgements:

- seq # of next byte expected from other side
- cumulative ACK

Q: how receiver handles out-of-order segments

- **A:** TCP spec doesn’t say, - up to implementor

outgoing segment from sender

source port #	dest port #
sequence number	
acknowledgement number	
	rwnd
checksum	urg pointer

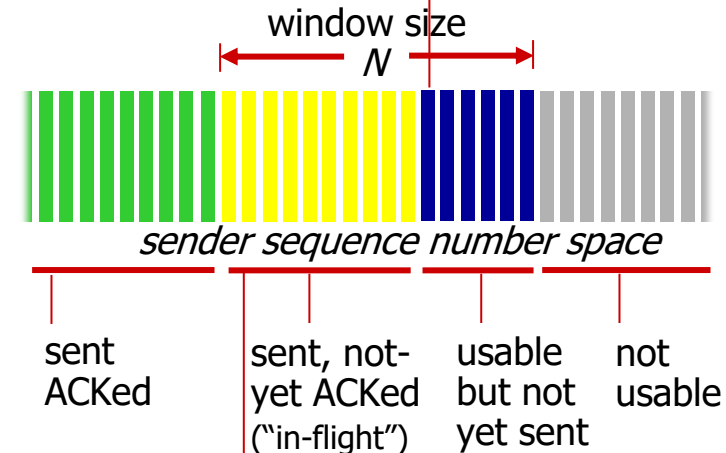

outgoing segment from receiver

source port #	dest port #
sequence number	
acknowledgement number	
	A
	rwnd
checksum	urg pointer

TCP sequence numbers, ACKs

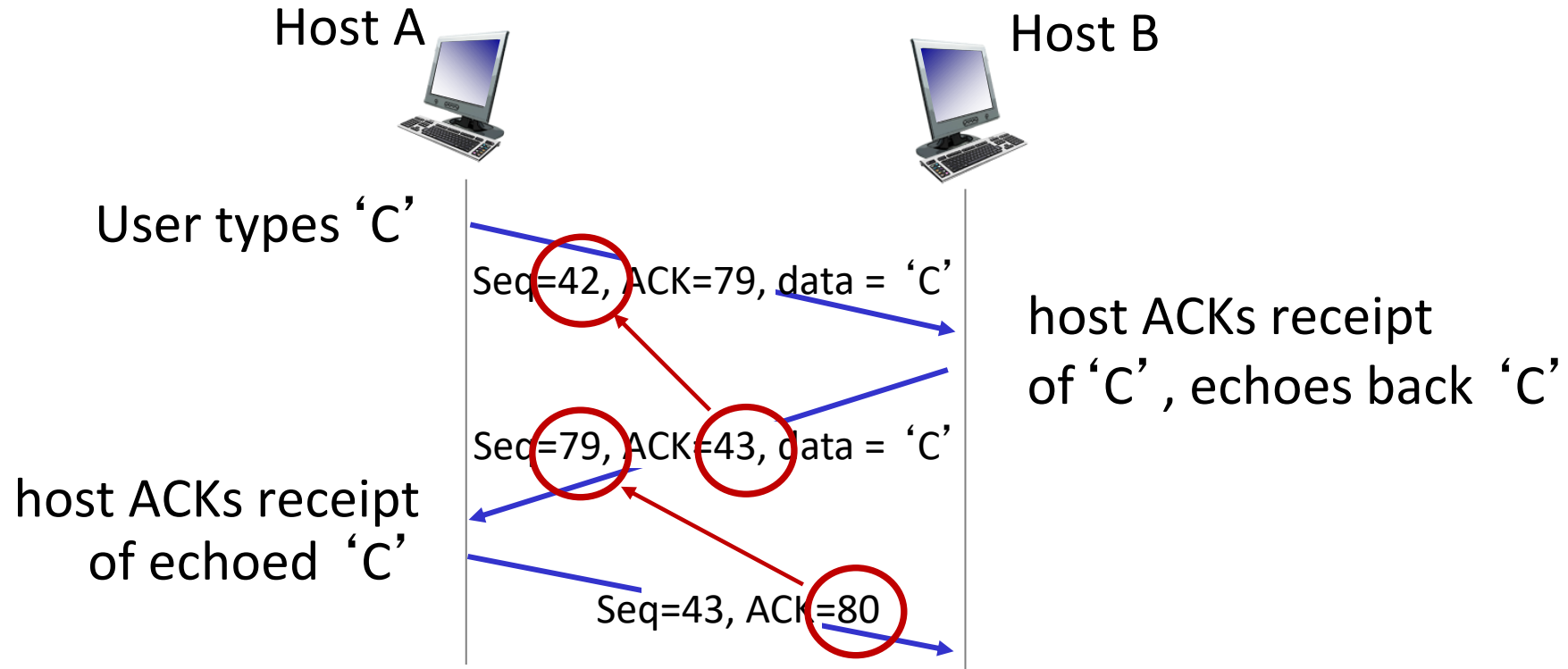

simple telnet scenario

TCP round trip time, timeout

Q: how to set TCP timeout value?

- longer than RTT, but RTT varies!
- *too short*: premature timeout, unnecessary retransmissions
- *too long*: slow reaction to segment loss

Q: how to estimate RTT?

- `SampleRTT`: measured time from segment transmission until ACK receipt
 - ignore retransmissions
- `SampleRTT` will vary, want estimated RTT “smoother”
 - average several *recent* measurements, not just current `SampleRTT`

TCP round trip time, timeout

$$\text{EstimatedRTT} = (1 - \alpha) * \text{EstimatedRTT} + \alpha * \text{SampleRTT}$$

- exponential weighted moving average (EWMA)
- influence of past sample decreases exponentially fast
- typical value: $\alpha = 0.125$

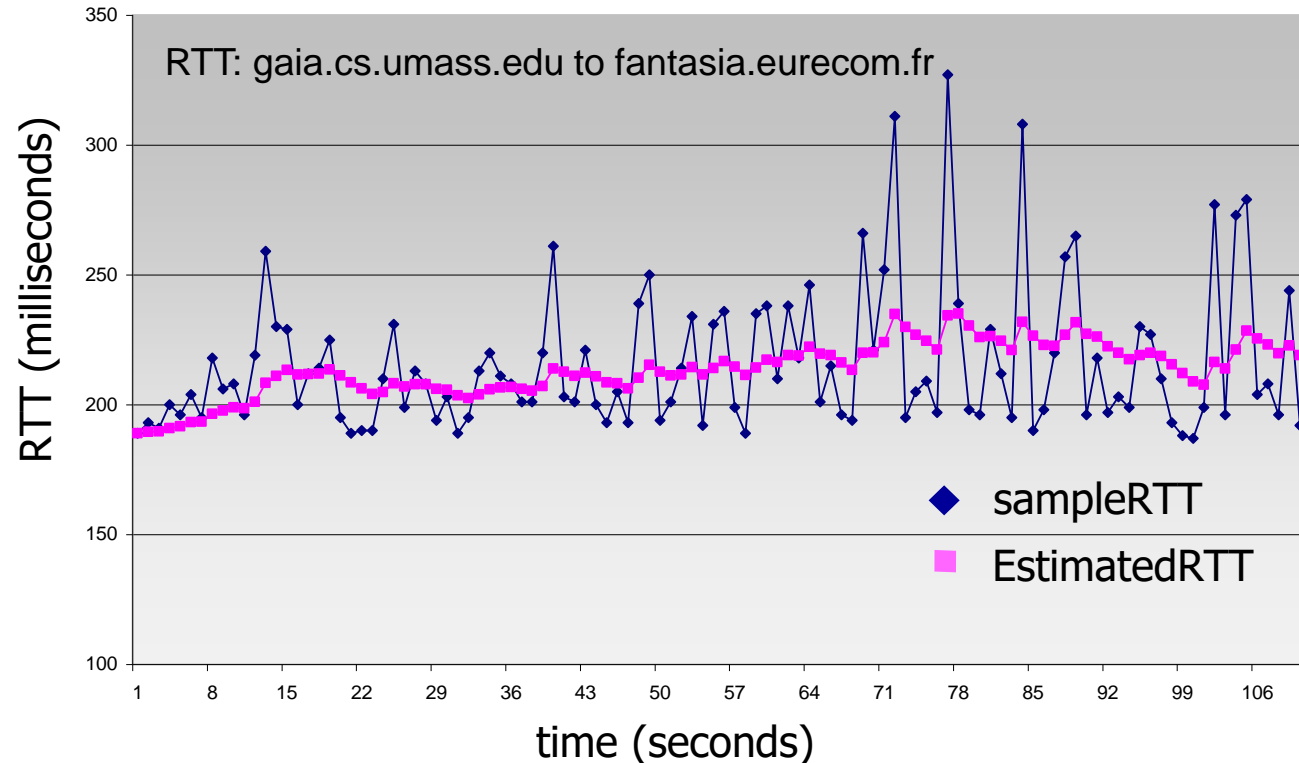

TCP round trip time, timeout

- timeout interval: **EstimatedRTT** plus “safety margin”
 - large variation in **EstimatedRTT**: want a larger safety margin

$$\text{TimeoutInterval} = \text{EstimatedRTT} + 4 * \text{DevRTT}$$



↑
estimated RTT

↑
“safety margin”

- **DevRTT**: EWMA of **SampleRTT** deviation from **EstimatedRTT**:

$$\text{DevRTT} = (1 - \beta) * \text{DevRTT} + \beta * |\text{SampleRTT} - \text{EstimatedRTT}|$$

(typically, $\beta = 0.25$)

* Check out the online interactive exercises for more examples: http://gaia.cs.umass.edu/kurose_ross/interactive/

TCP Sender (simplified)

event: data received from application

- create segment with seq #
- seq # is byte-stream number of first data byte in segment
- start timer if not already running
 - think of timer as for oldest unACKed segment
 - expiration interval: **TimeOutInterval**

event: timeout

- retransmit segment that caused timeout
- restart timer

event: ACK received

- if ACK acknowledges previously unACKed segments
 - update what is known to be ACKed
 - start timer if there are still unACKed segments

TCP Receiver: ACK generation [RFC 5681]

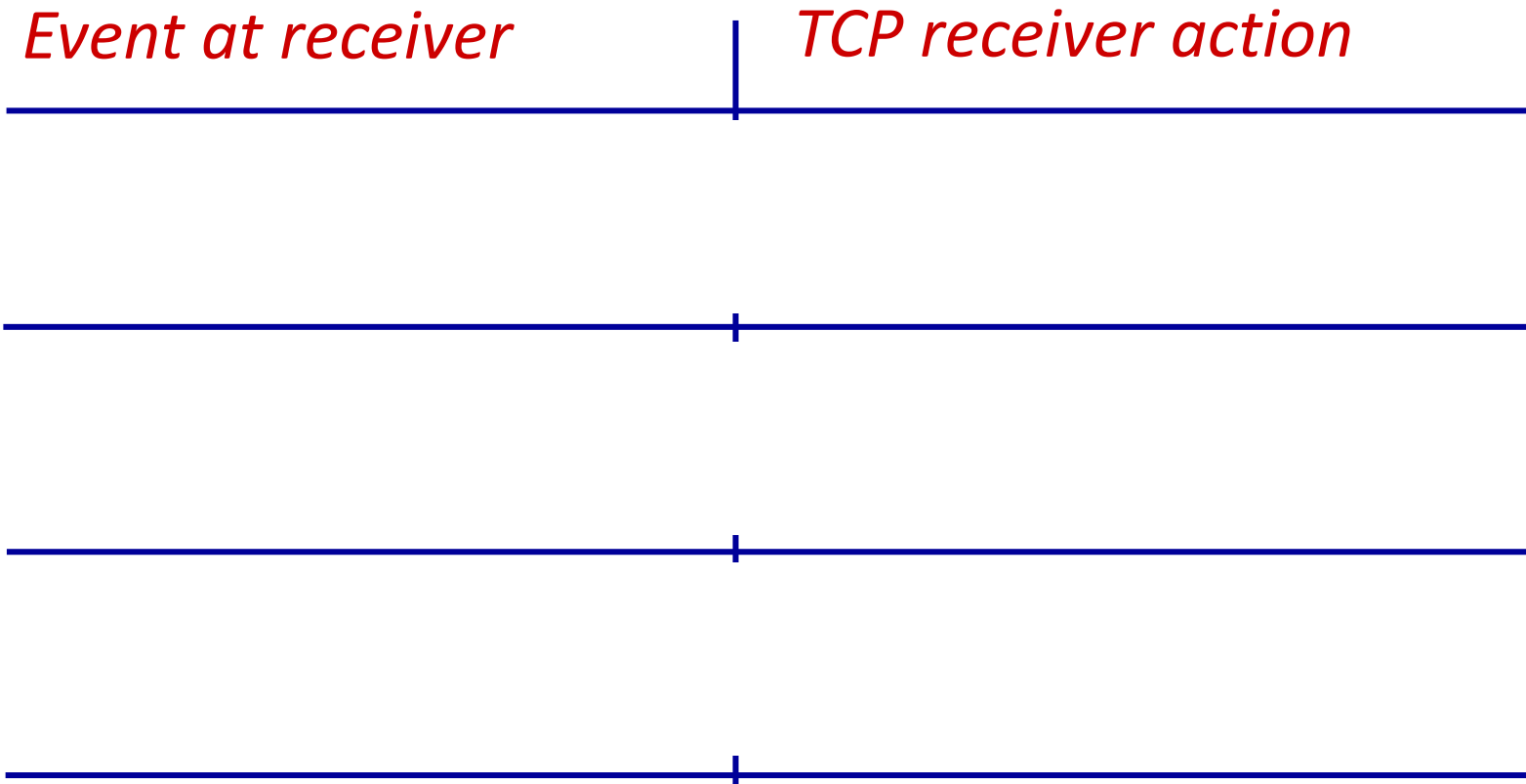

TCP: retransmission scenarios

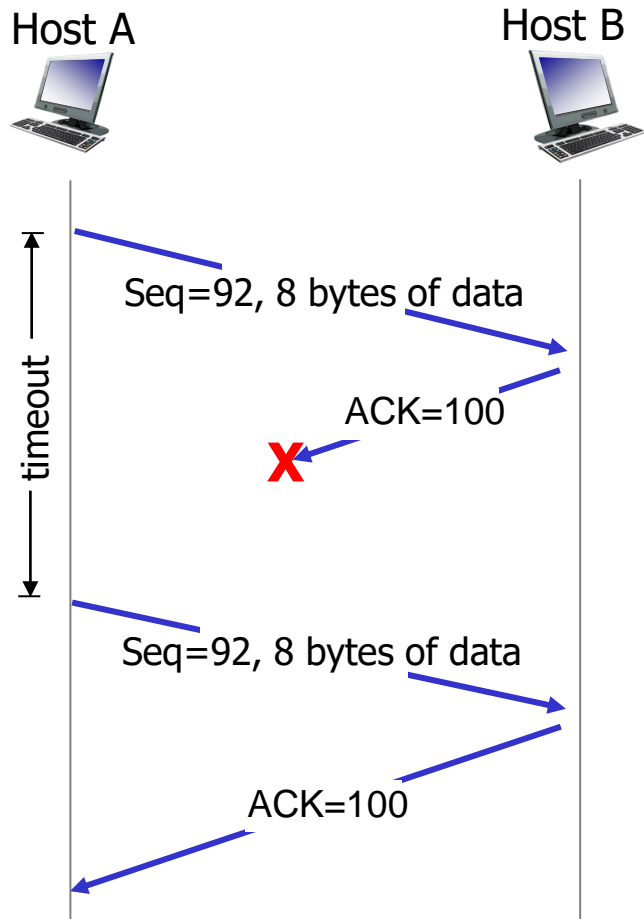

lost ACK scenario

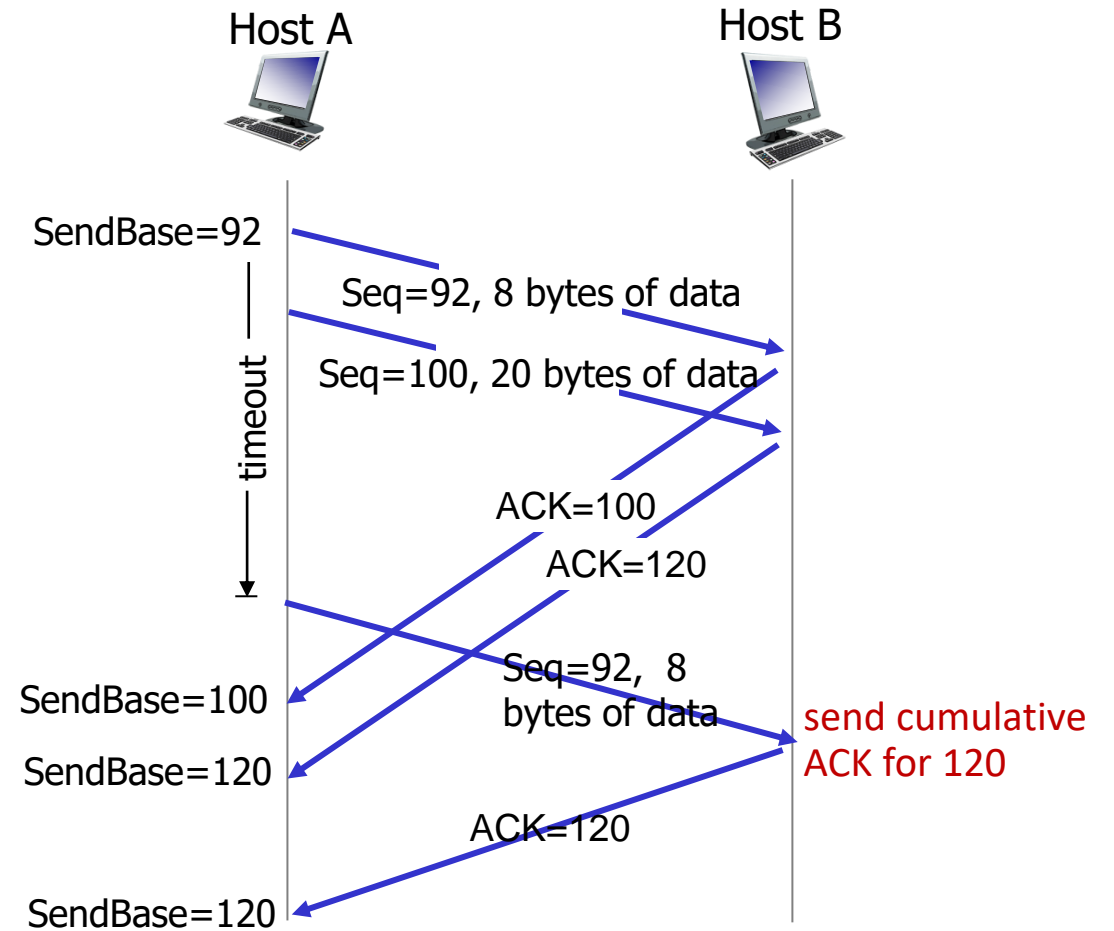

premature timeout

TCP: retransmission scenarios

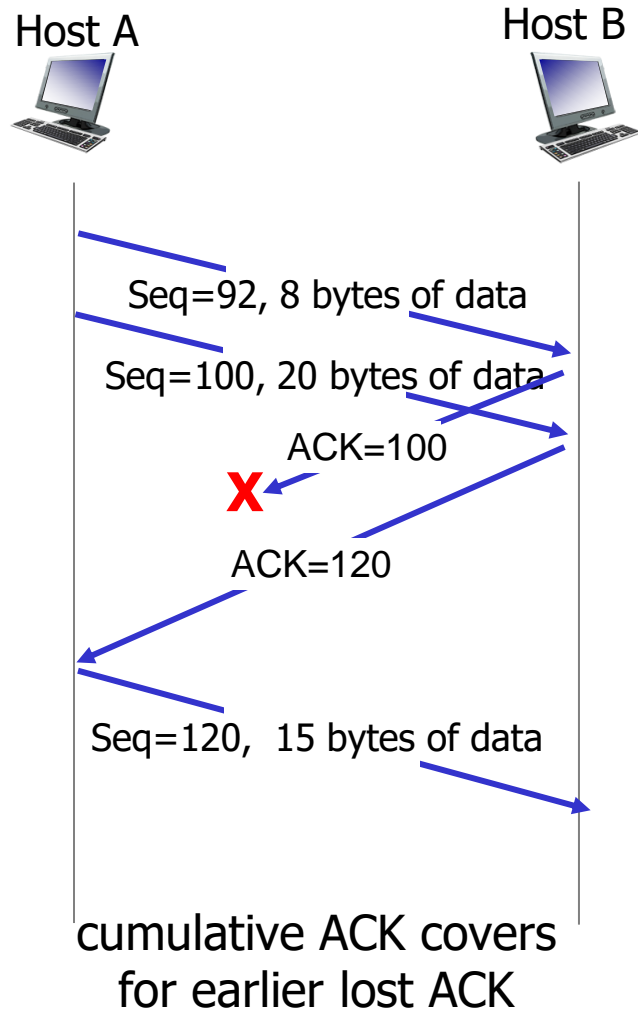

TCP fast retransmit

TCP fast retransmit

if sender receives 3 additional ACKs for same data (“triple duplicate ACKs”), resend unACKed segment with smallest seq #

- likely that unACKed segment lost, so don't wait for timeout



Receipt of three duplicate ACKs indicates 3 segments received after a missing segment – lost segment is likely. So retransmit!

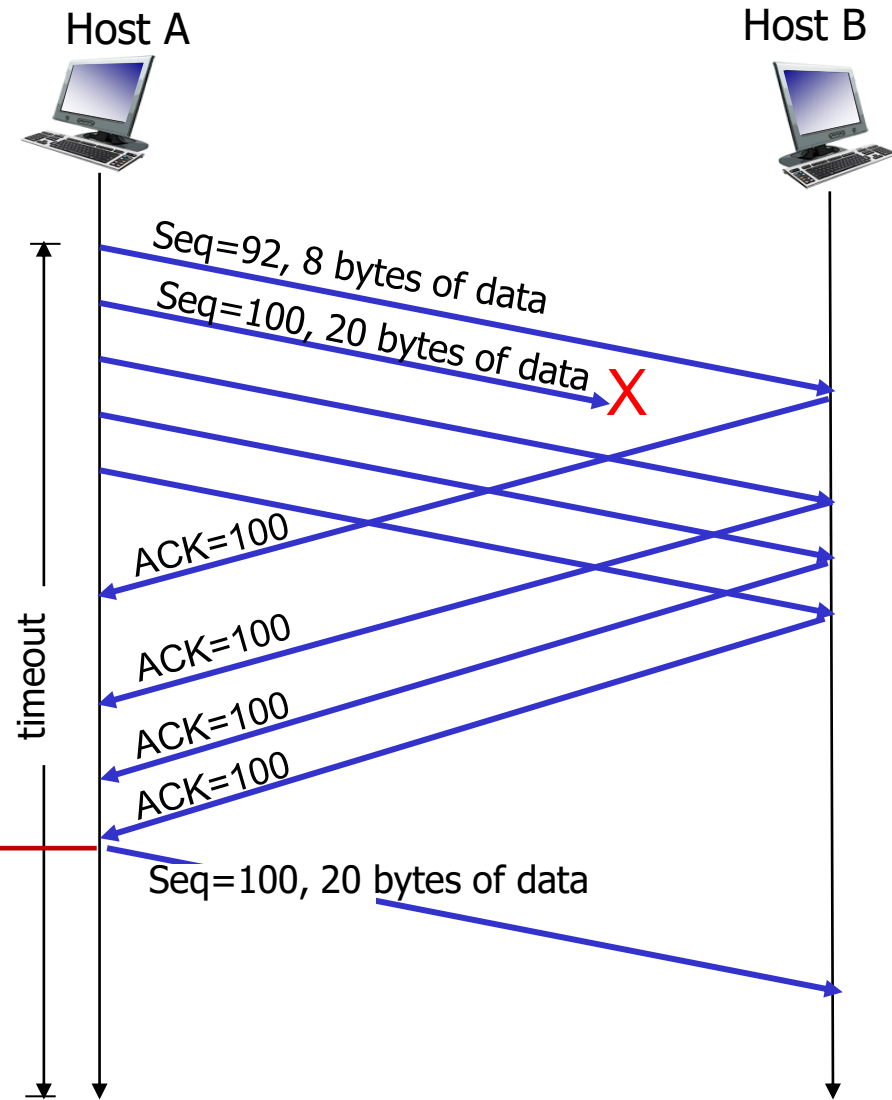

Chapter 3: roadmap

- Transport-layer services
- Multiplexing and demultiplexing
- Connectionless transport: UDP
- Principles of reliable data transfer
- **Connection-oriented transport: TCP**
 - segment structure
 - reliable data transfer
 - flow control
 - connection management
- Principles of congestion control
- TCP congestion control



TCP flow control

Q: What happens if network layer delivers data faster than application layer removes data from socket buffers?

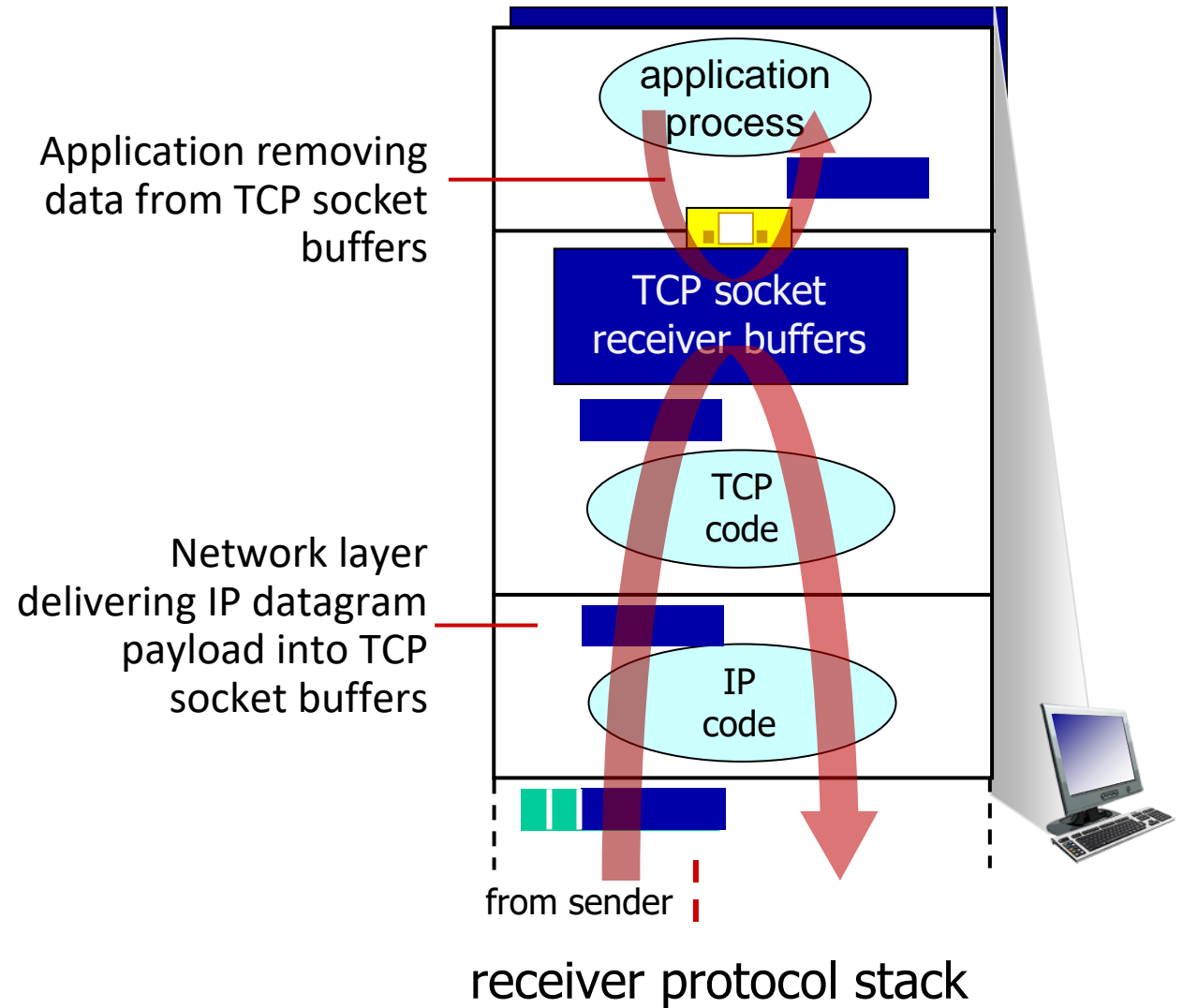

TCP flow control

Q: What happens if network layer delivers data faster than application layer removes data from socket buffers?

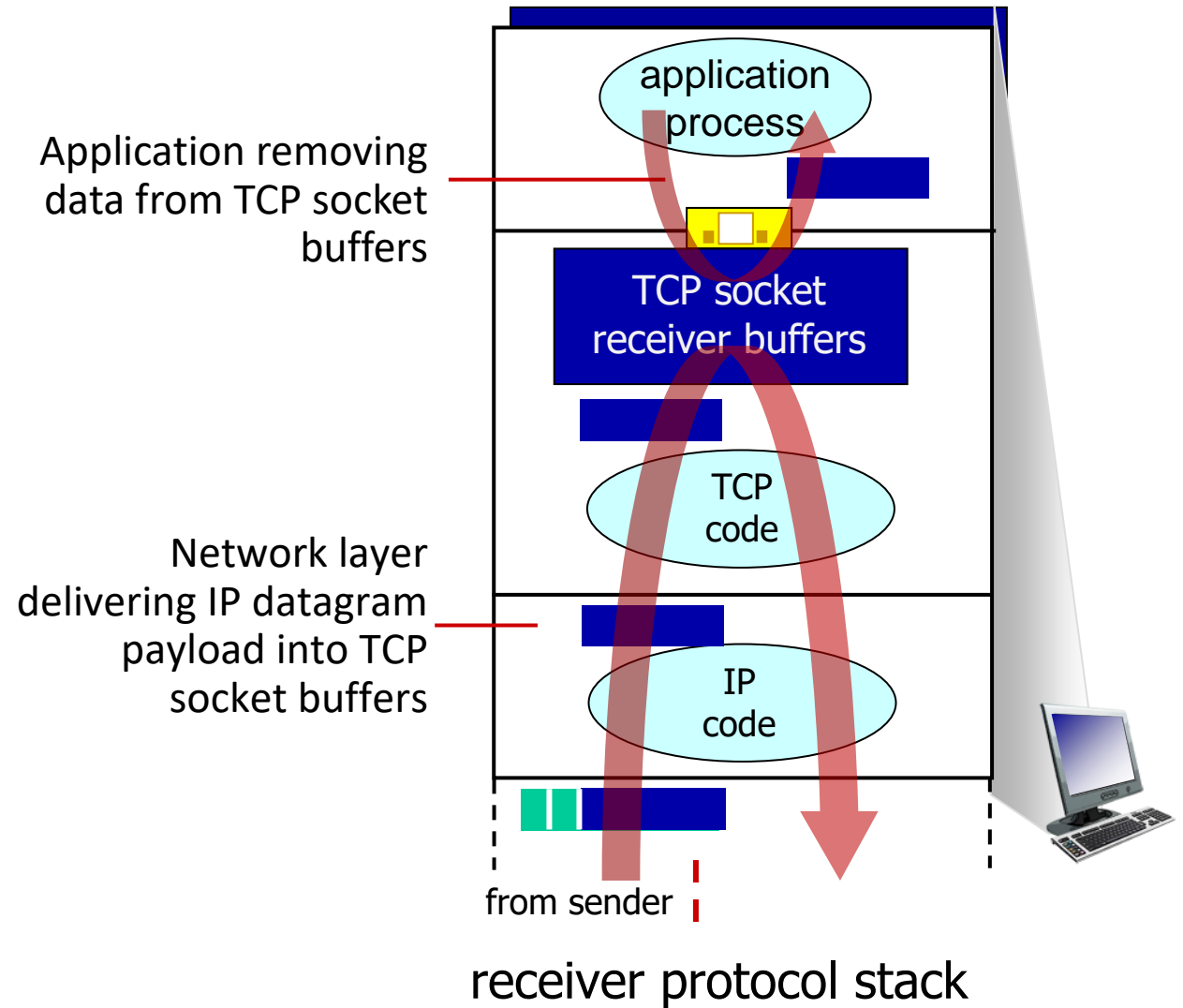

TCP flow control

Q: What happens if network layer delivers data faster than application layer removes data from socket buffers?

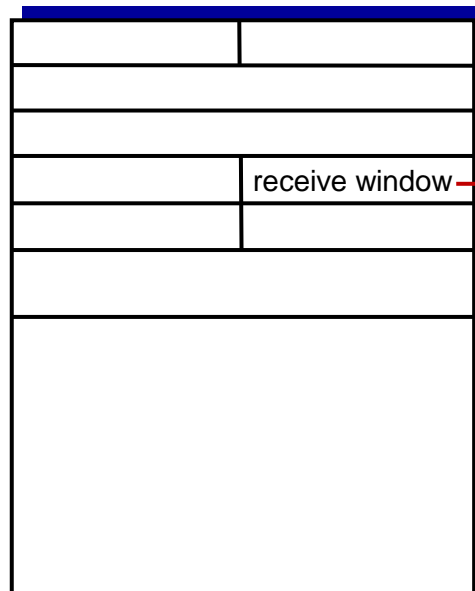

flow control: # bytes receiver willing to accept

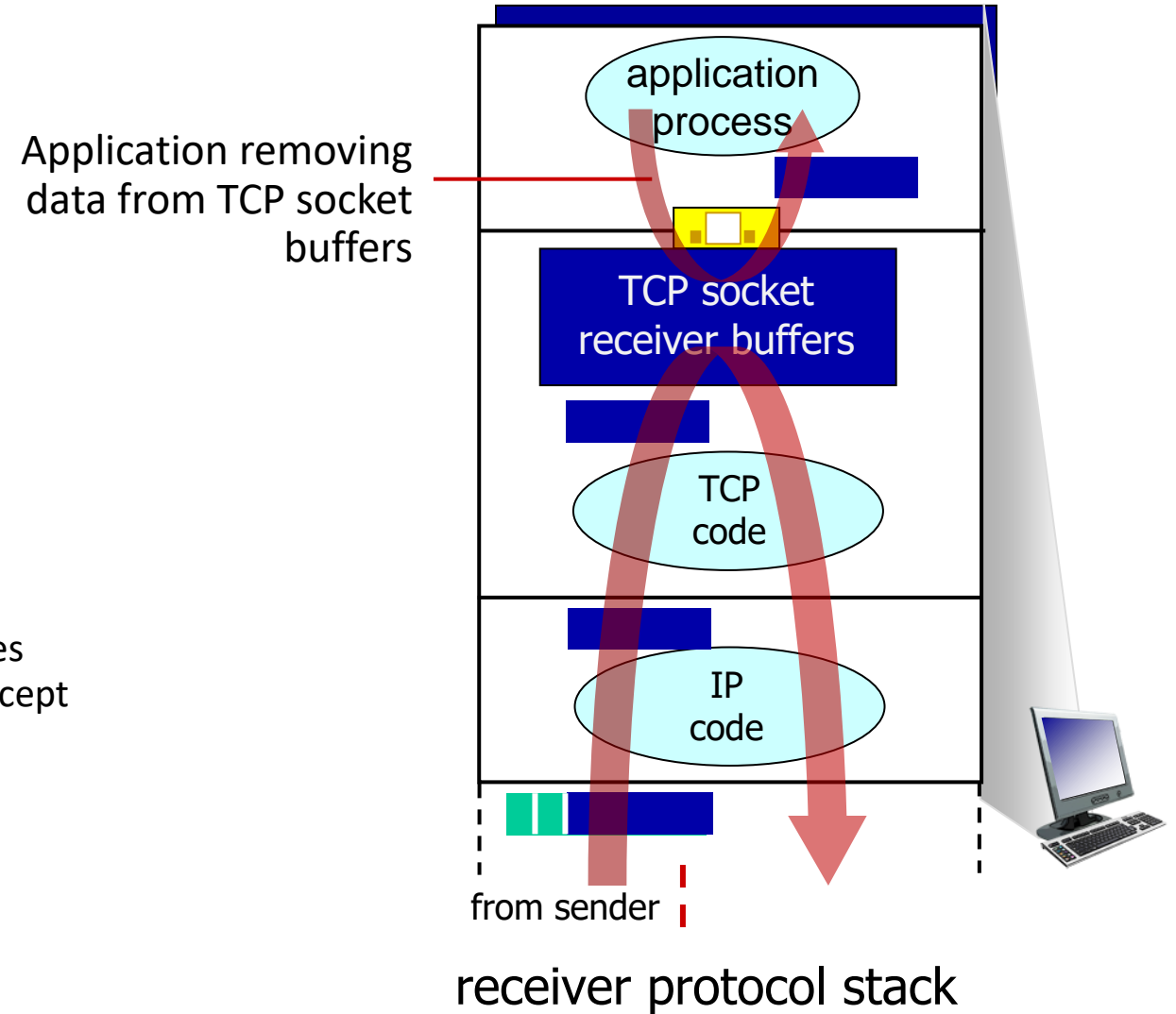

TCP flow control

Q: What happens if network layer delivers data faster than application layer removes data from socket buffers?

flow control

receiver controls sender, so sender won't overflow receiver's buffer by transmitting too much, too fast

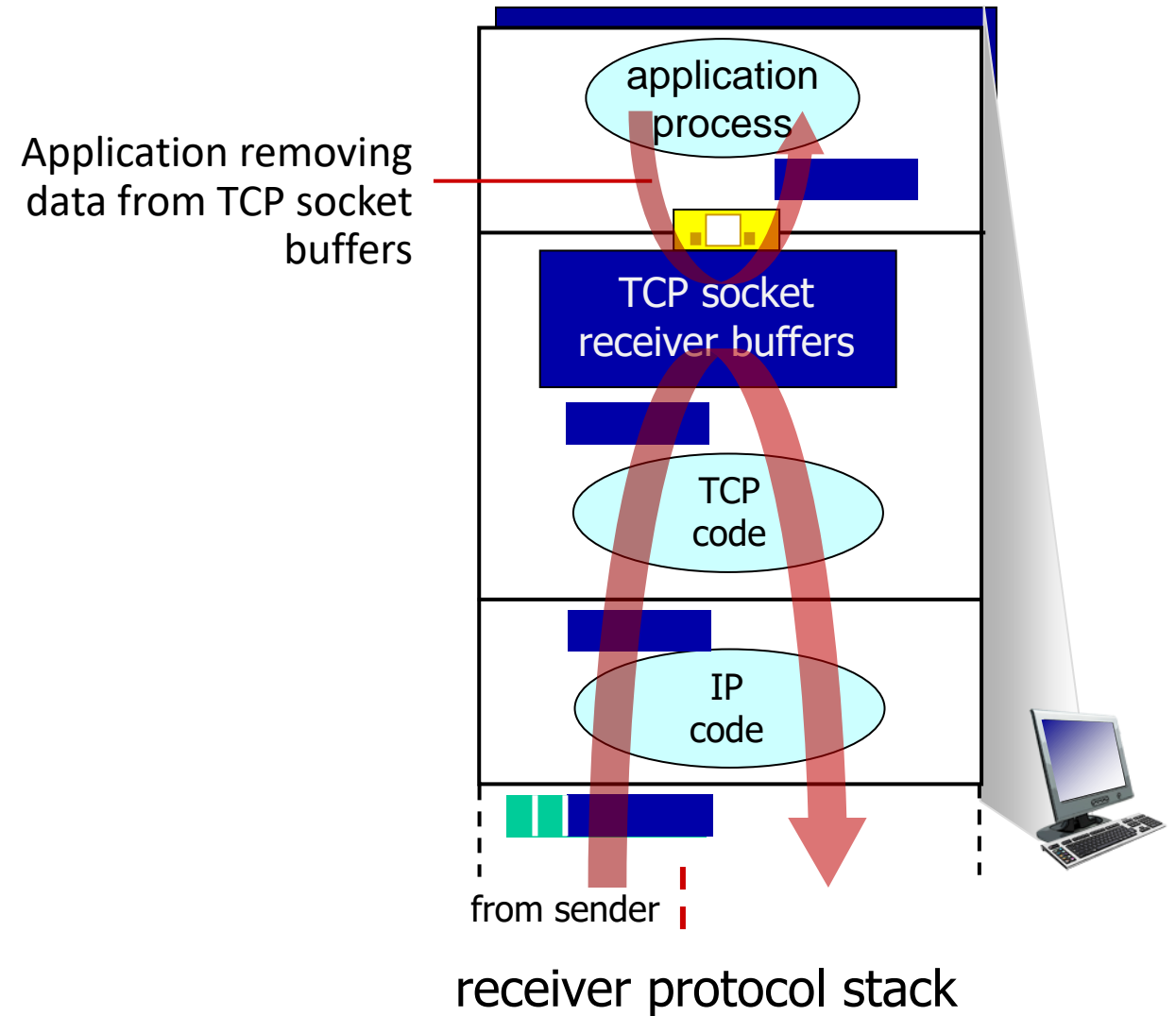

TCP flow control

- TCP receiver “advertises” free buffer space in **rwnd** field in TCP header
 - **RcvBuffer** size set via socket options (typical default is 4096 bytes)
 - many operating systems autoadjust **RcvBuffer**
- sender limits amount of unACKed (“in-flight”) data to received **rwnd**
- guarantees receive buffer will not overflow

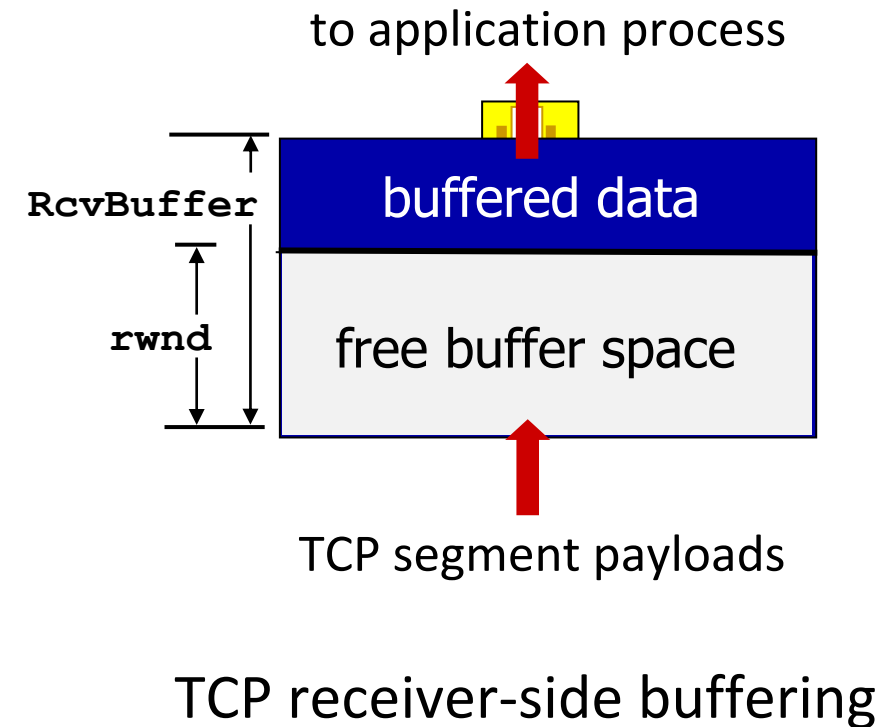

TCP flow control

- TCP receiver “advertises” free buffer space in **rwnd** field in TCP header
 - **RcvBuffer** size set via socket options (typical default is 4096 bytes)
 - many operating systems autoadjust **RcvBuffer**
- sender limits amount of unACKed (“in-flight”) data to received **rwnd**
- guarantees receive buffer will not overflow

flow control: # bytes receiver willing to accept

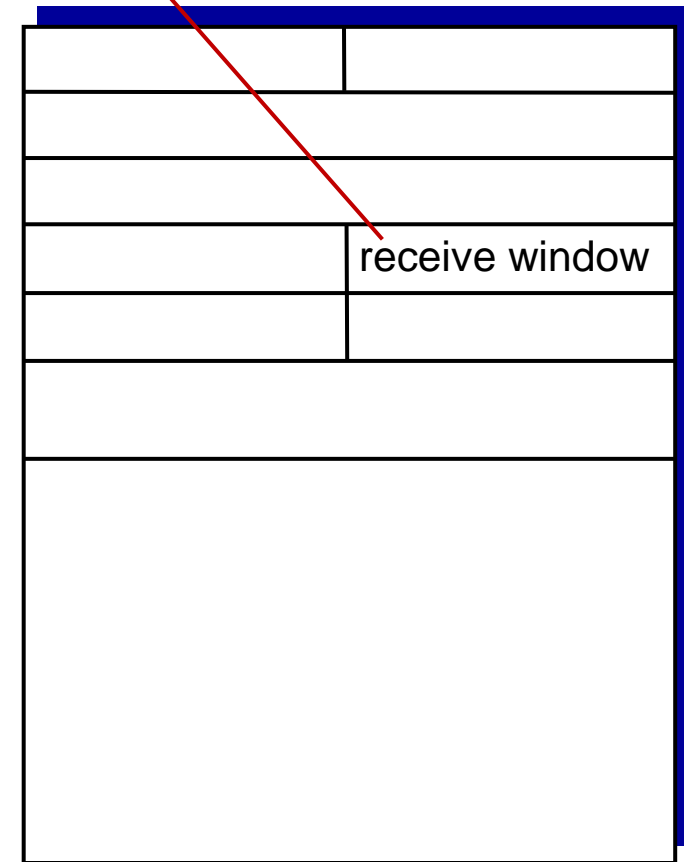

TCP segment format

TCP connection management

before exchanging data, sender/receiver “handshake”:

- agree to establish connection (each knowing the other willing to establish connection)
- agree on connection parameters (e.g., starting seq #s)

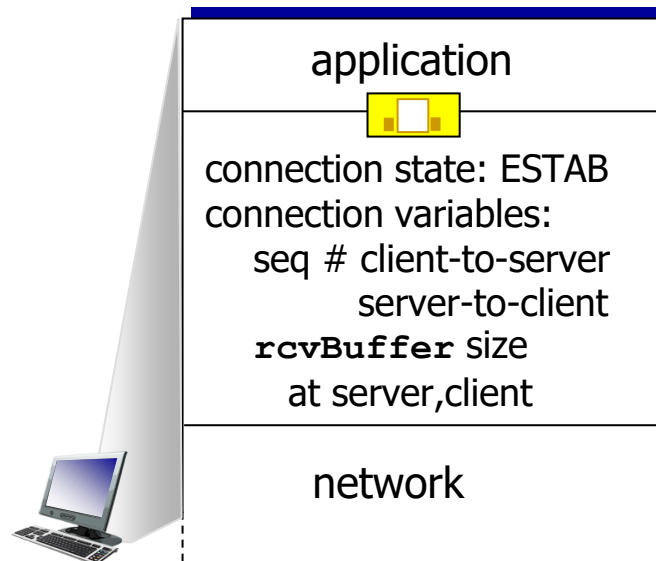

```
Socket clientSocket =  
    newSocket("hostname", "port number");
```

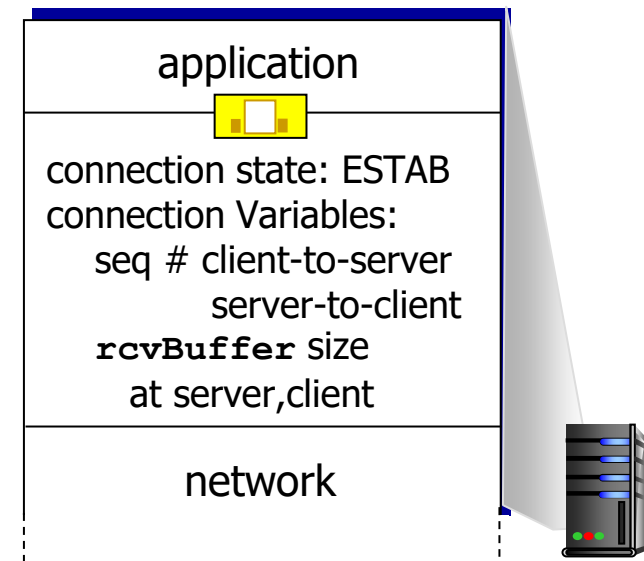

```
Socket connectionSocket =  
    welcomeSocket.accept();
```

Agreeing to establish a connection

2-way handshake:

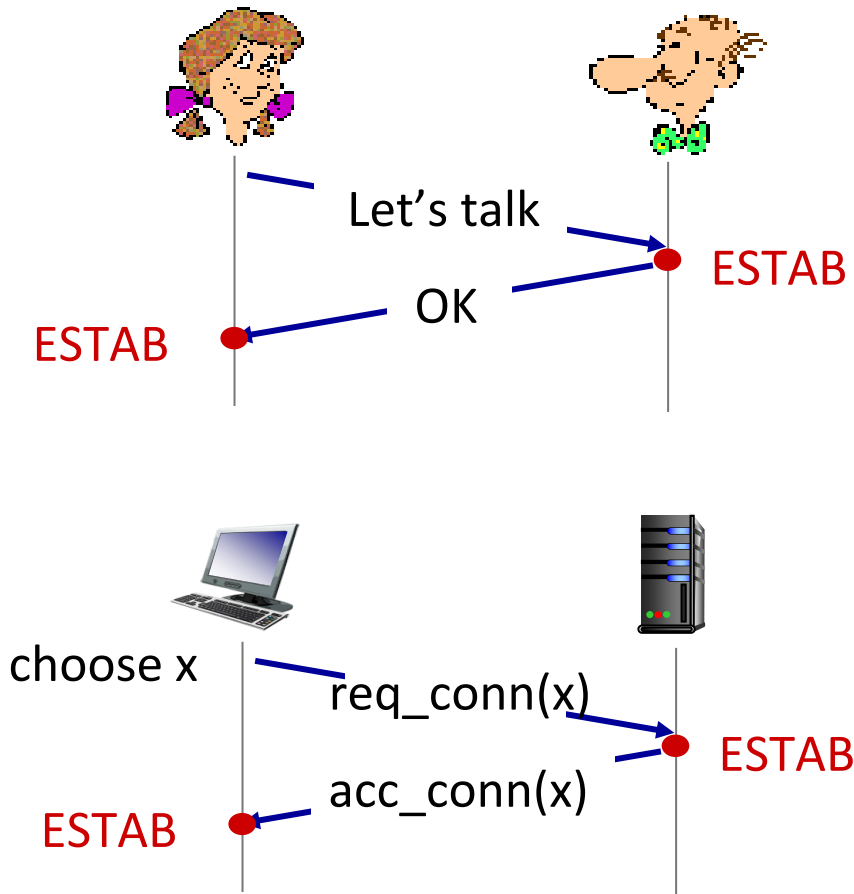

Q: will 2-way handshake always work in network?

- variable delays
- retransmitted messages (e.g. req_conn(x)) due to message loss
- message reordering
- can't "see" other side

2-way handshake scenarios

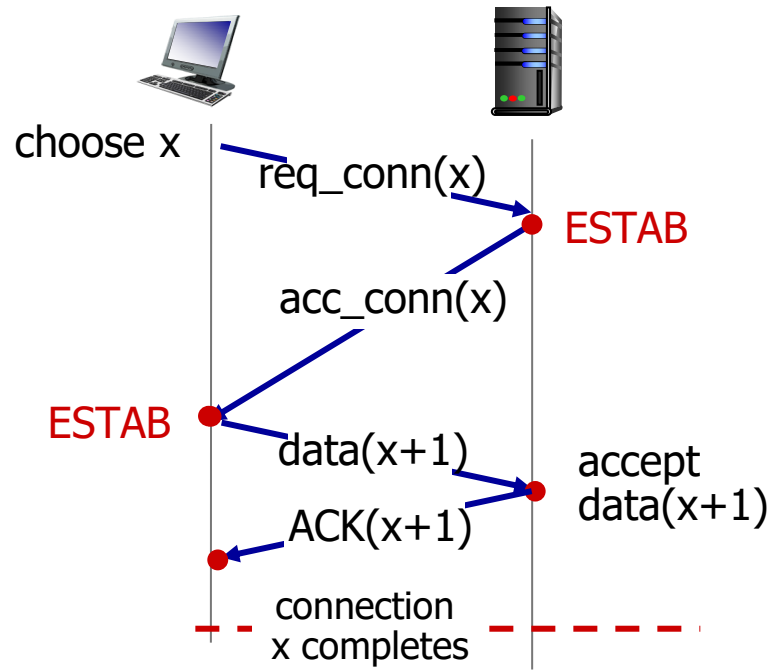

No problem!



2-way handshake scenarios

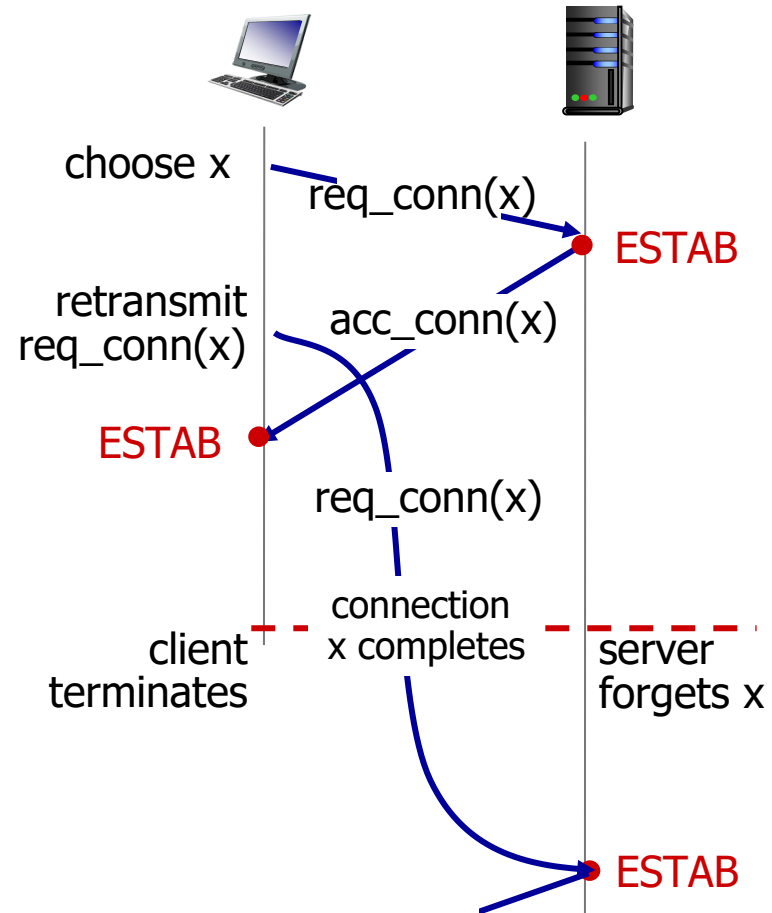

 Problem: half open connection! (no client)

2-way handshake scenarios

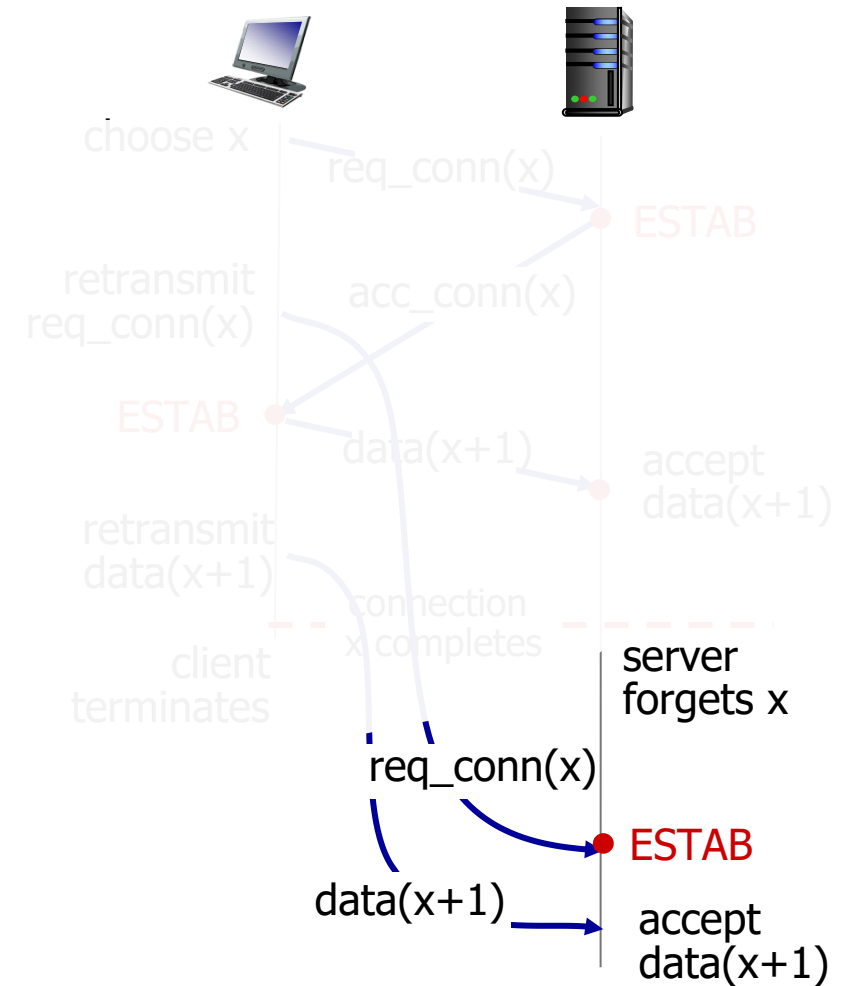

✘ Problem: dup data accepted!

TCP 3-way handshake

Client state

```
clientSocket = socket(AF_INET, SOCK_STREAM)
```

LISTEN

```
clientSocket.connect((serverName, serverPort))
```

SYNSENT

ESTAB

choose init seq num, x
send TCP SYN msg

received SYNACK(x)
indicates server is live;
send ACK for SYNACK;
this segment may contain
client-to-server data



SYNbit=1, Seq=x

SYNbit=1, Seq=y
ACKbit=1; ACKnum=x+1

ACKbit=1, ACKnum=y+1

received ACK(y)
indicates client is live

Server state

```
serverSocket = socket(AF_INET, SOCK_STREAM)  
serverSocket.bind(('', serverPort))  
serverSocket.listen(1)  
connectionSocket, addr = serverSocket.accept()
```

LISTEN

SYN RCVD

ESTAB

A human 3-way handshake protocol



Closing a TCP connection

- client, server each close their side of connection
 - send TCP segment with FIN bit = 1
- respond to received FIN with ACK
 - on receiving FIN, ACK can be combined with own FIN
- simultaneous FIN exchanges can be handled

Chapter 3: roadmap

- Transport-layer services
- Multiplexing and demultiplexing
- Connectionless transport: UDP
- Principles of reliable data transfer
- Connection-oriented transport: TCP
- **Principles of congestion control**
- TCP congestion control
- Evolution of transport-layer functionality



Principles of congestion control

Congestion:

- informally: “too many sources sending too much data too fast for *network* to handle”
- manifestations:
 - long delays (queueing in router buffers)
 - packet loss (buffer overflow at routers)
- different from flow control!
- a top-10 problem!



congestion control:

too many senders,
sending too fast

flow control: one sender
too fast for one receiver

Causes/costs of congestion: scenario 1

Simplest scenario:

- one router, infinite buffers
- input, output link capacity: R
- two flows
- no retransmissions needed

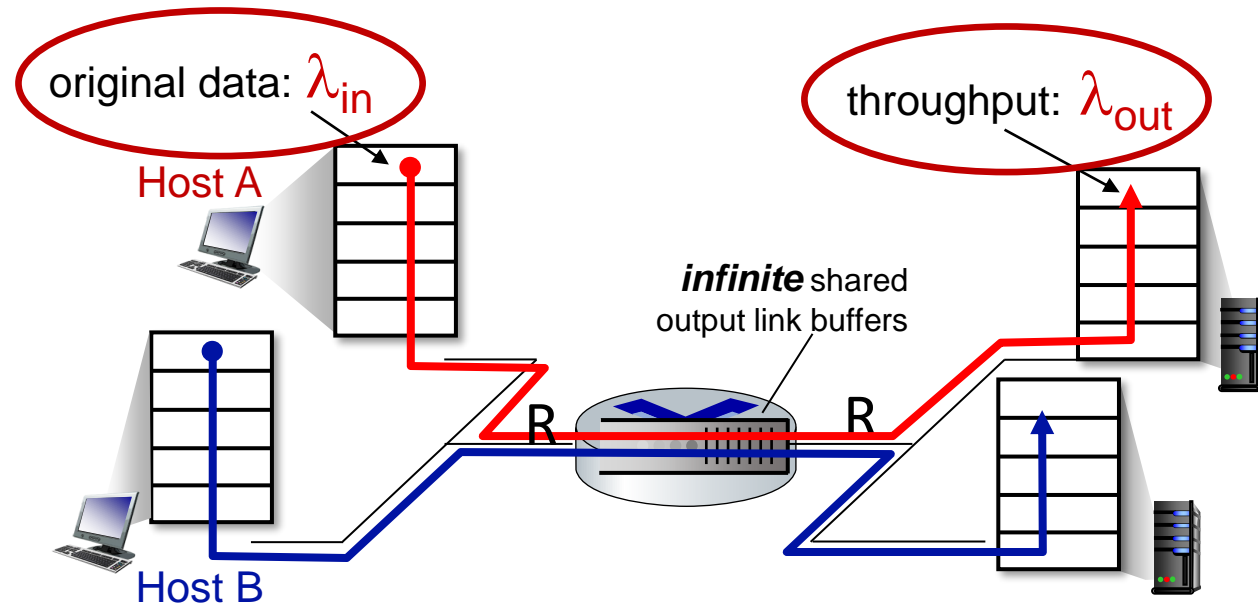

Q: What happens as arrival rate λ_{in} approaches $R/2$?

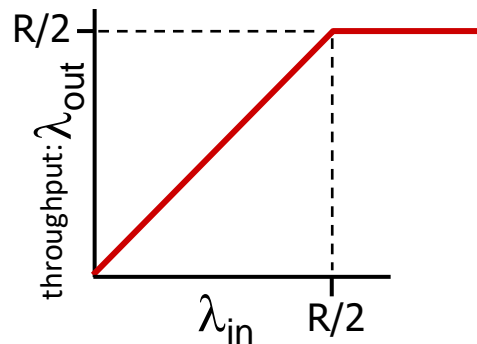

maximum per-connection throughput: $R/2$

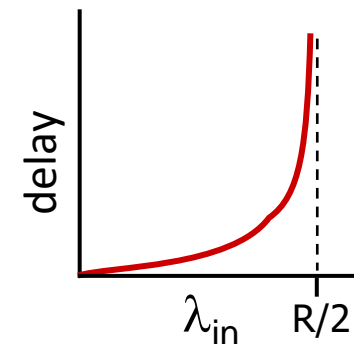

large delays as arrival rate λ_{in} approaches capacity

Causes/costs of congestion: scenario 2

- one router, *finite* buffers
- sender retransmits lost, timed-out packet
 - application-layer input = application-layer output: $\lambda_{in} = \lambda_{out}$
 - transport-layer input includes *retransmissions* : $\lambda'_{in} \geq \lambda_{in}$

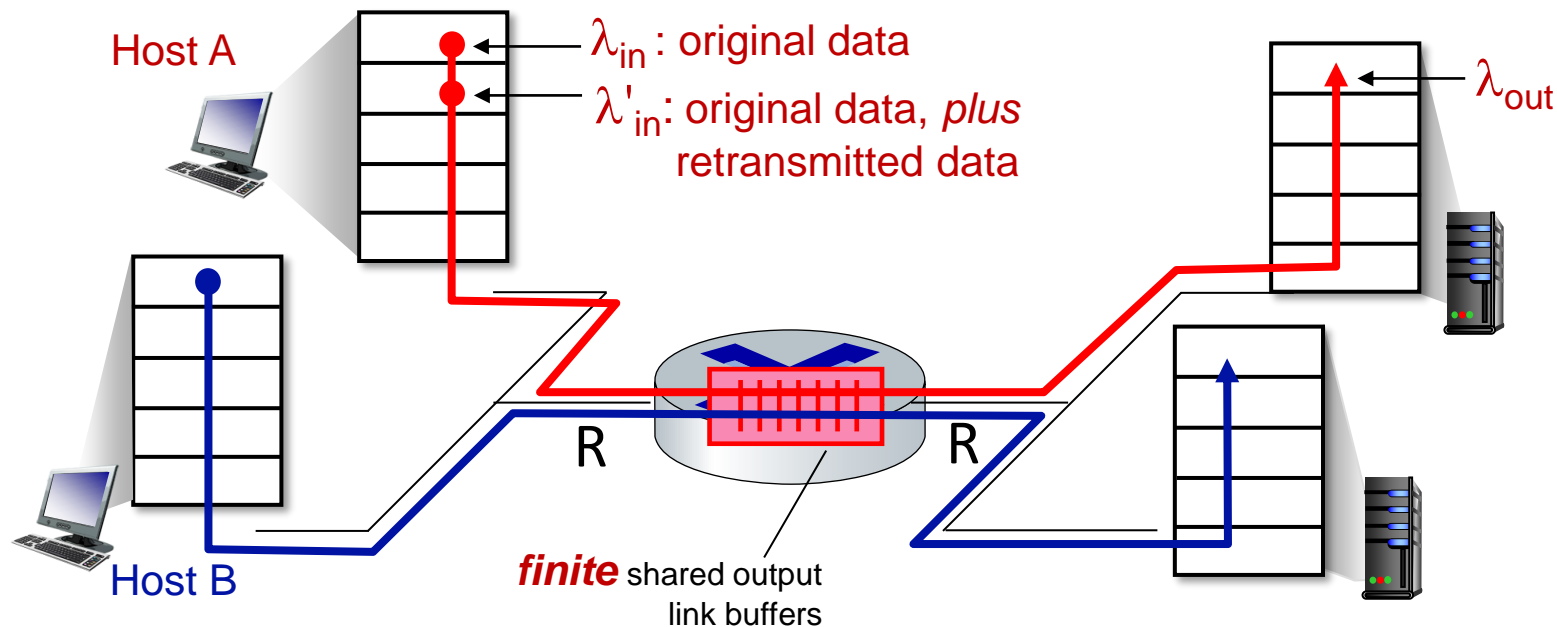

Causes/costs of congestion: scenario 2

Idealization: perfect knowledge

- sender sends only when router buffers available

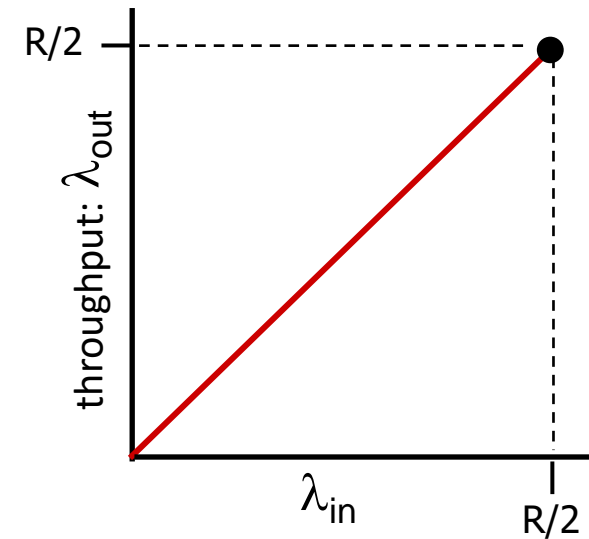
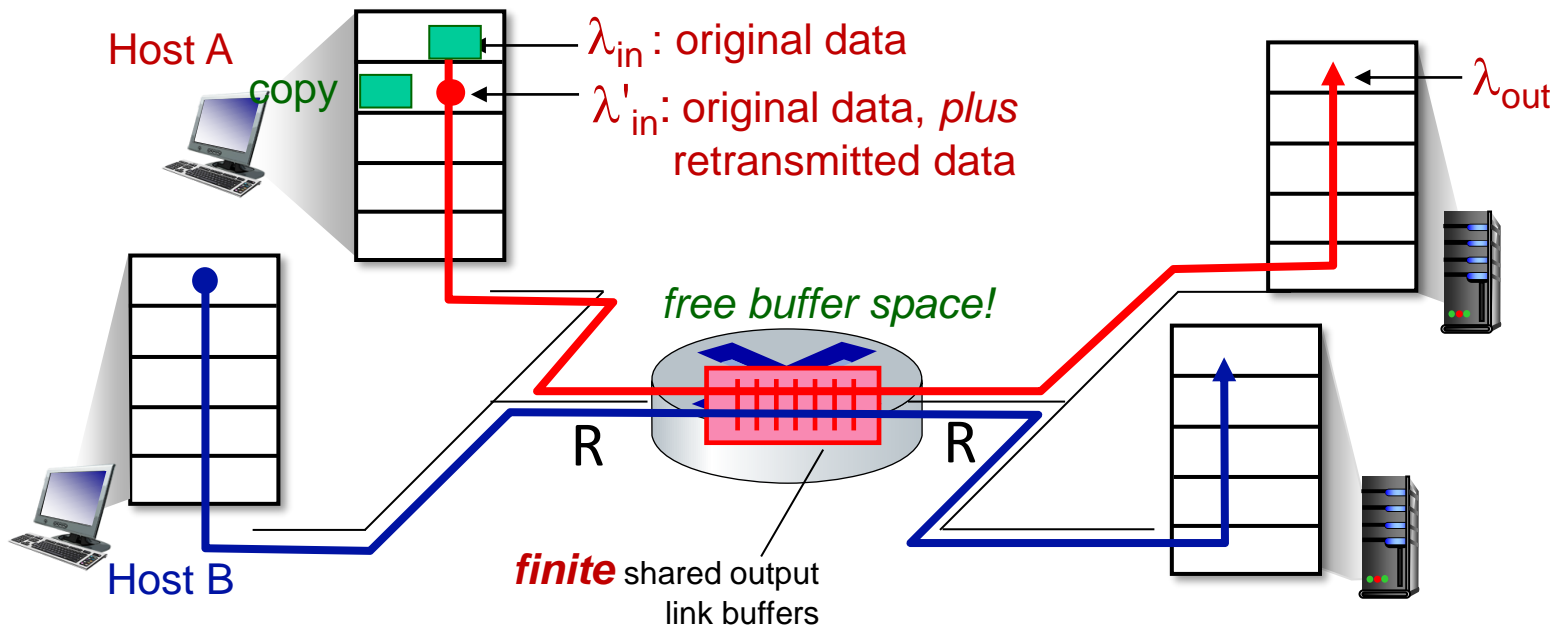

Causes/costs of congestion: scenario 2

Idealization: *some* perfect knowledge

- packets can be lost (dropped at router) due to full buffers
- sender knows when packet has been dropped: only resends if packet *known* to be lost

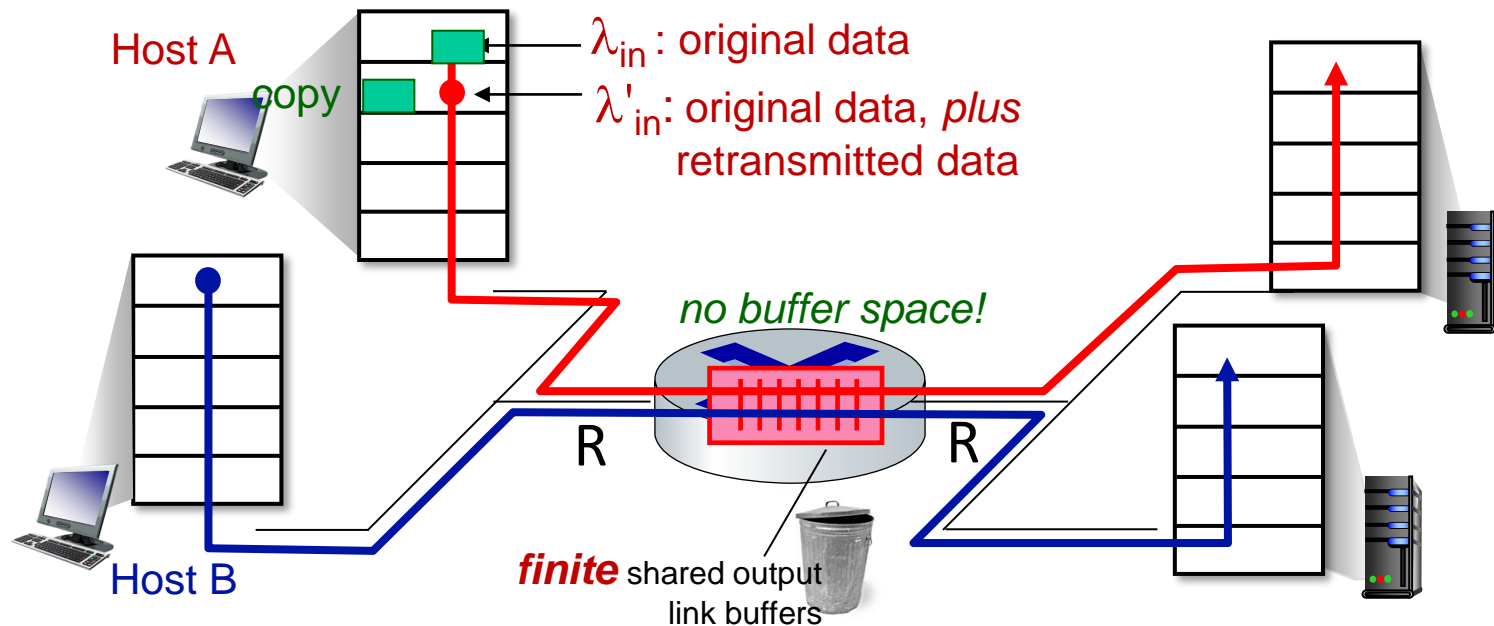

Causes/costs of congestion: scenario 2

Idealization: *some* perfect knowledge

- packets can be lost (dropped at router) due to full buffers
- sender knows when packet has been dropped: only resends if packet *known* to be lost

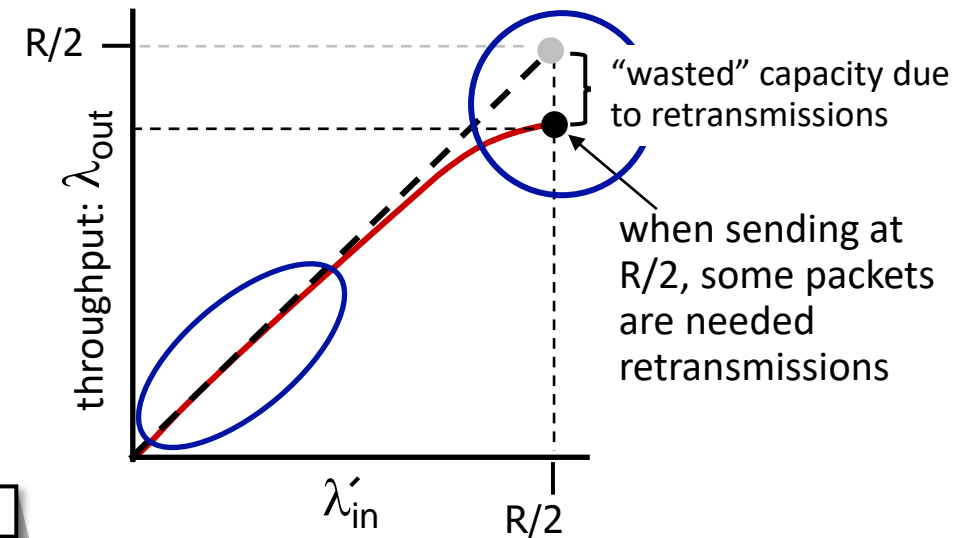
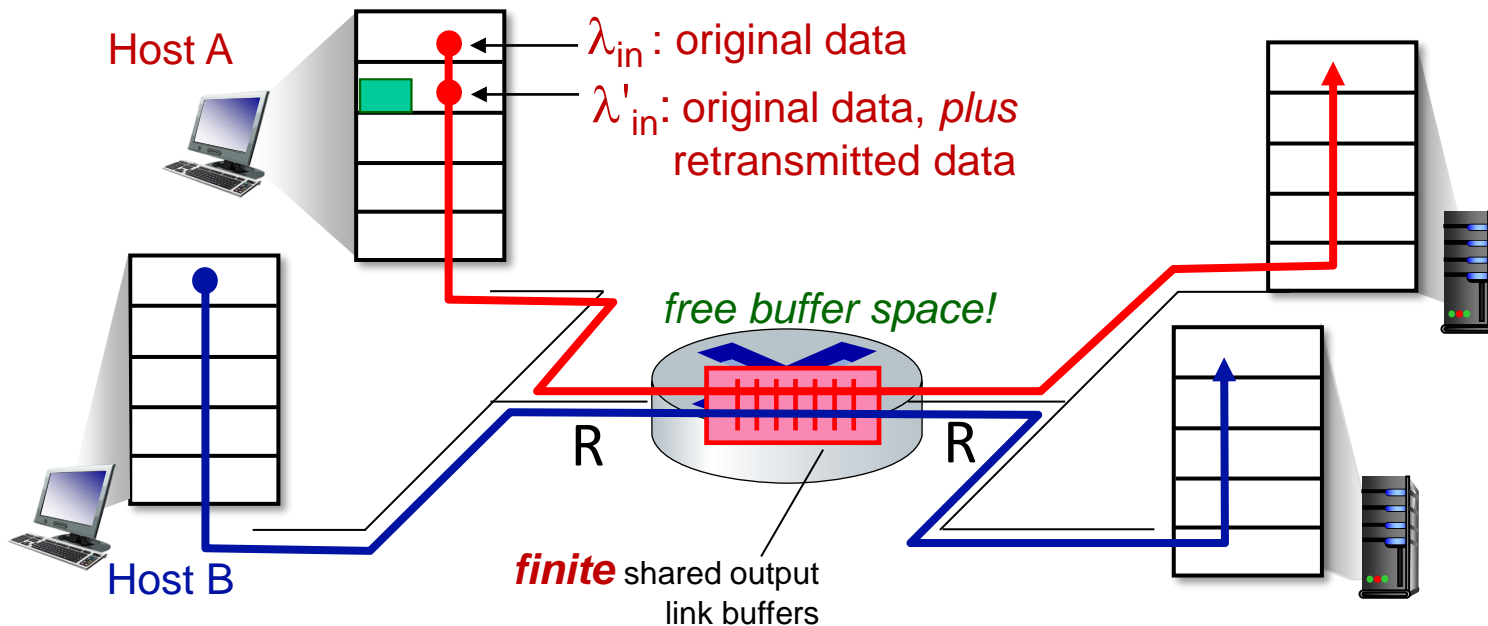

Causes/costs of congestion: scenario 2

Realistic scenario: *un-needed duplicates*

- packets can be lost, dropped at router due to full buffers – requiring retransmissions
- but sender times can time out prematurely, sending *two* copies, *both* of which are delivered

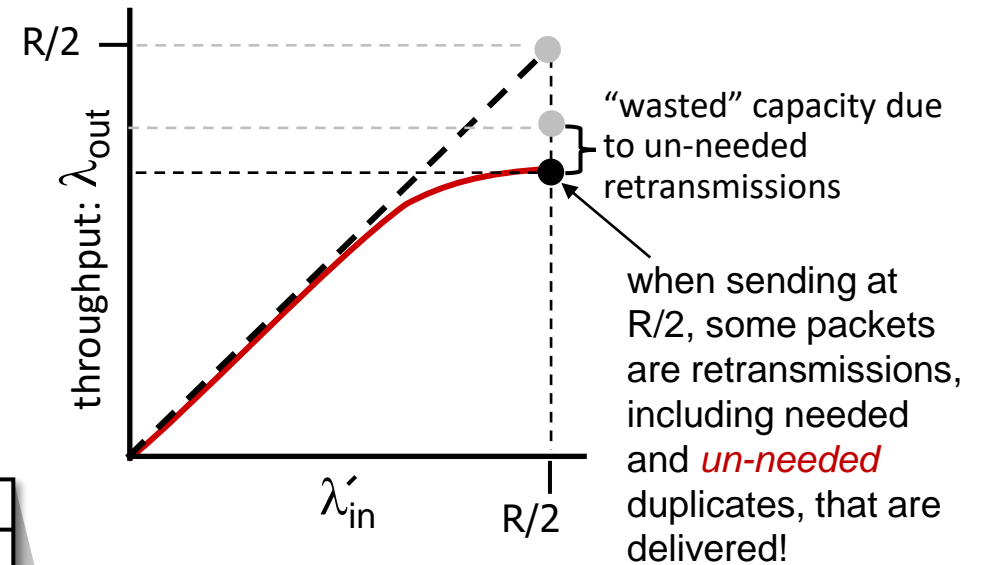
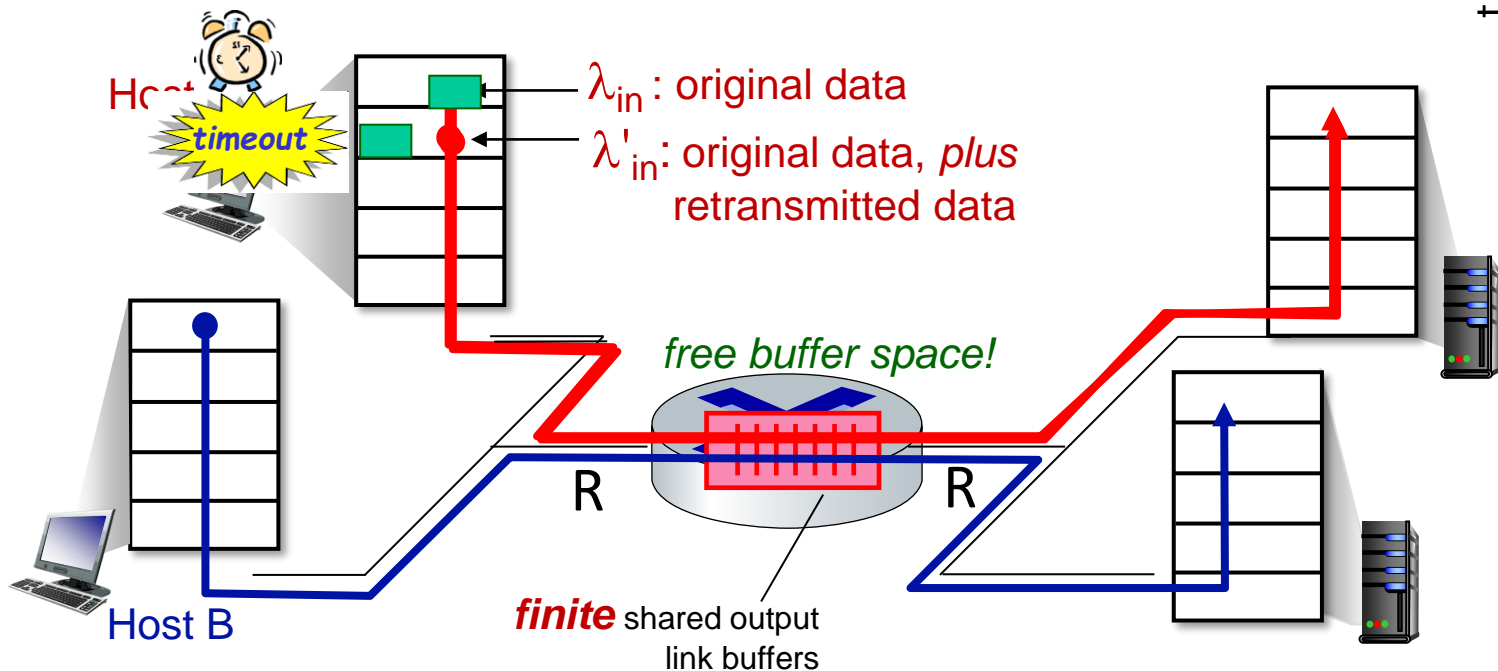

Causes/costs of congestion: scenario 2

Realistic scenario: *un-needed duplicates*

- packets can be lost, dropped at router due to full buffers – requiring retransmissions
- but sender times can time out prematurely, sending *two* copies, *both* of which are delivered

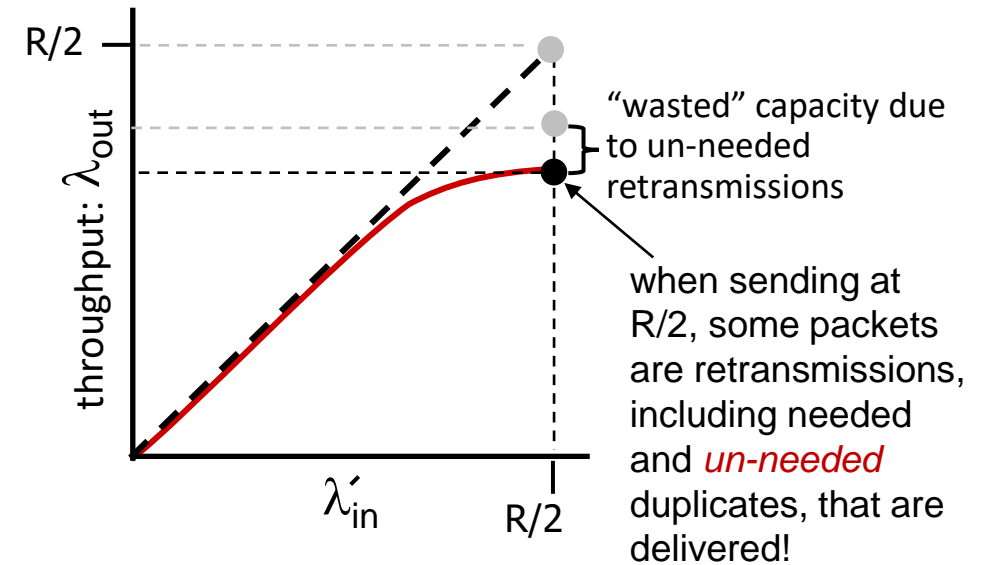

"costs" of congestion:

- more work (retransmission) for given receiver throughput
- unneeded retransmissions: link carries multiple copies of a packet
 - decreasing maximum achievable throughput

Causes/costs of congestion: scenario 3

- *four* senders
- *multi-hop* paths
- timeout/retransmit

Q: what happens as λ_{in} and λ'_{in} increase ?

A: as red λ'_{in} increases, all arriving blue pkts at upper queue are dropped, blue throughput $\rightarrow 0$

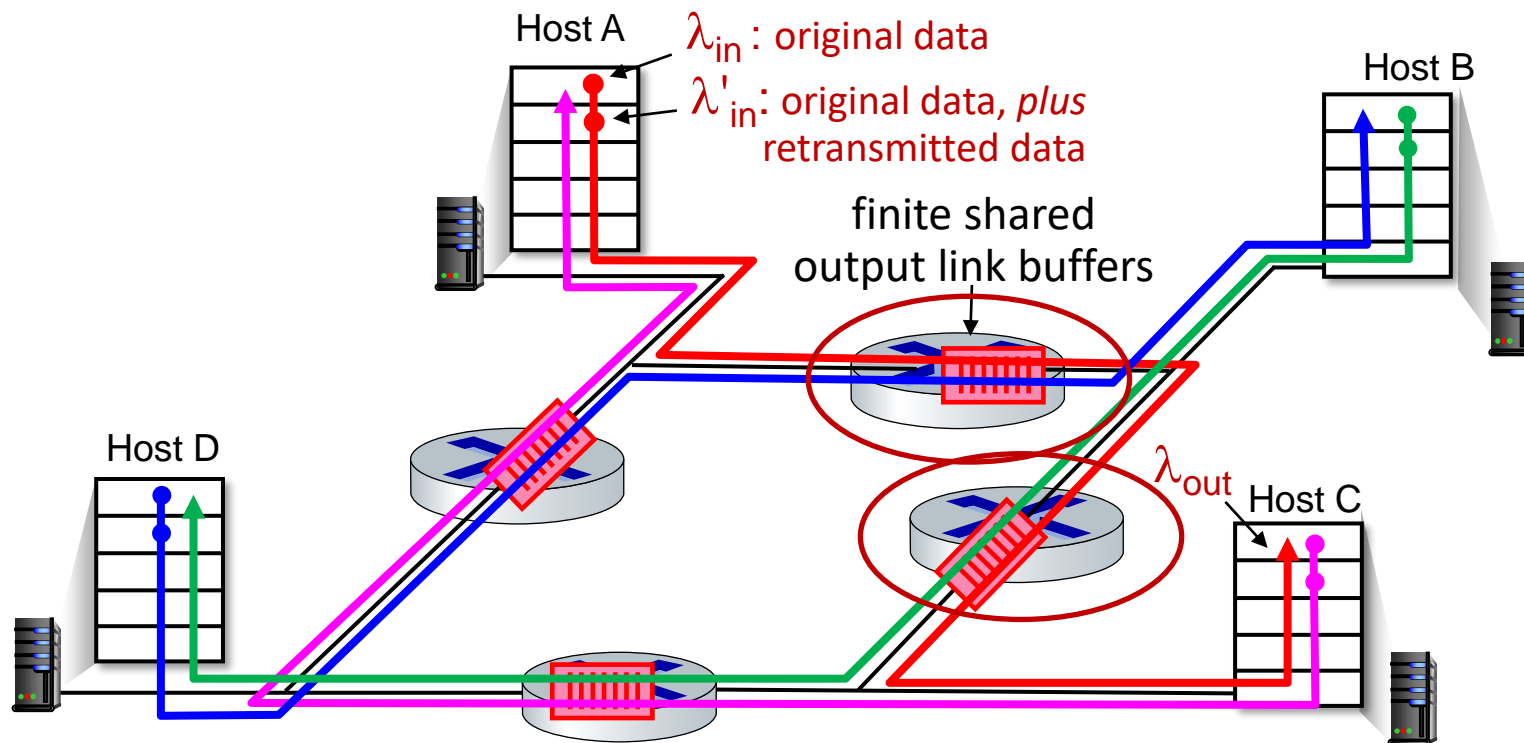

Causes/costs of congestion: scenario 3

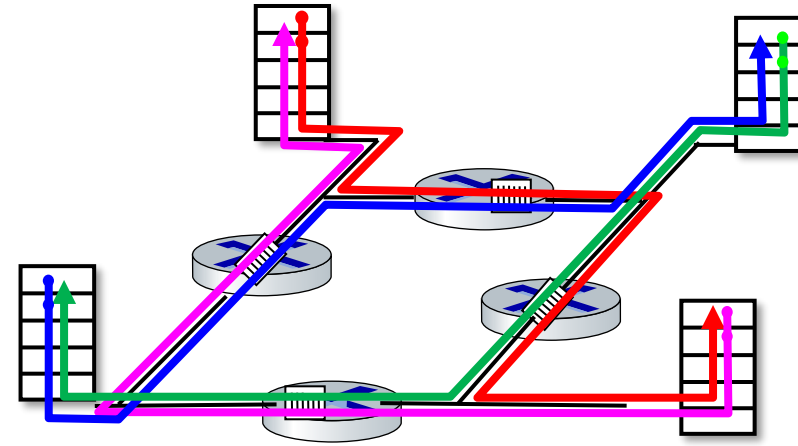
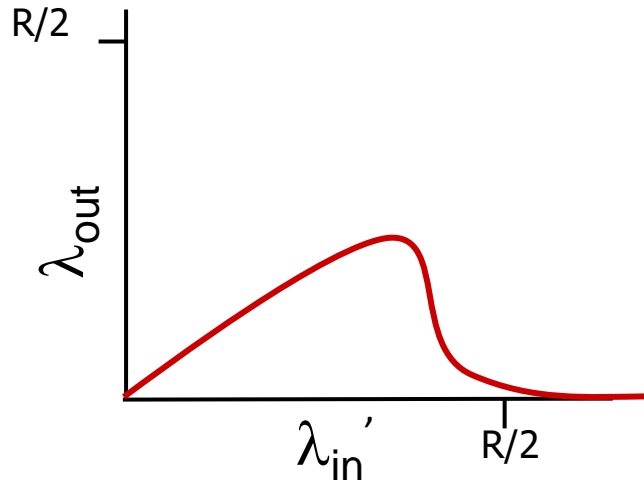

another “cost” of congestion:

- when packet dropped, any upstream transmission capacity and buffering used for that packet was wasted!

Causes/costs of congestion: insights

- throughput can never exceed capacity
- delay increases as capacity approached
- loss/retransmission decreases effective throughput
- un-needed duplicates further decreases effective throughput
- upstream transmission capacity / buffering wasted for packets lost downstream

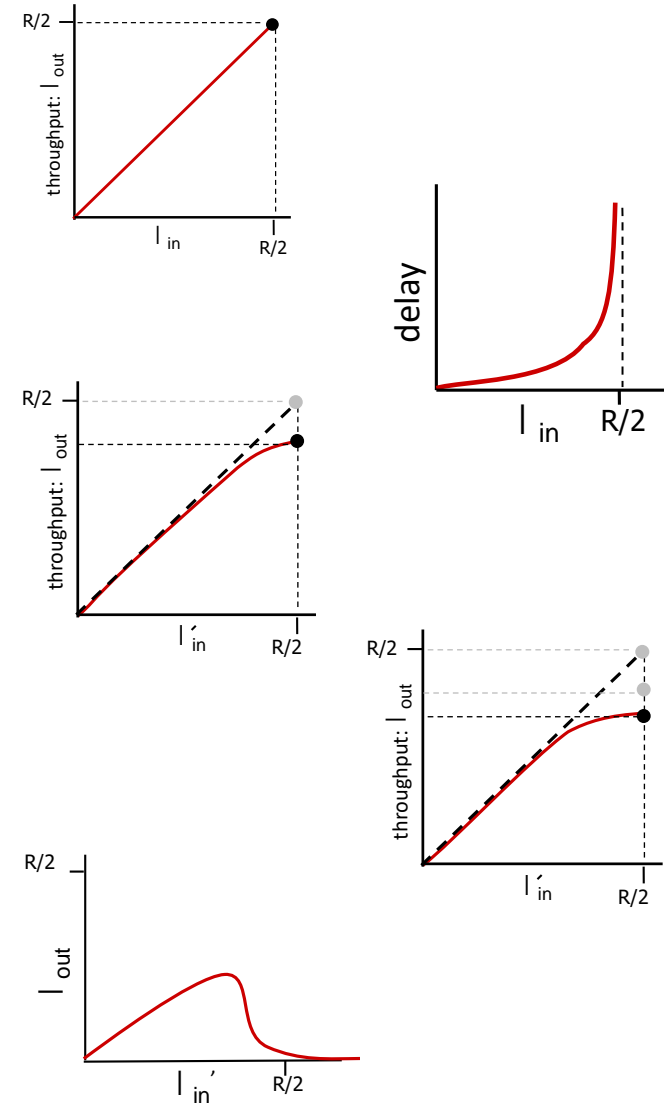

Approaches towards congestion control

End-end congestion control:

- no explicit feedback from network
- congestion *inferred* from observed loss, delay
- approach taken by TCP

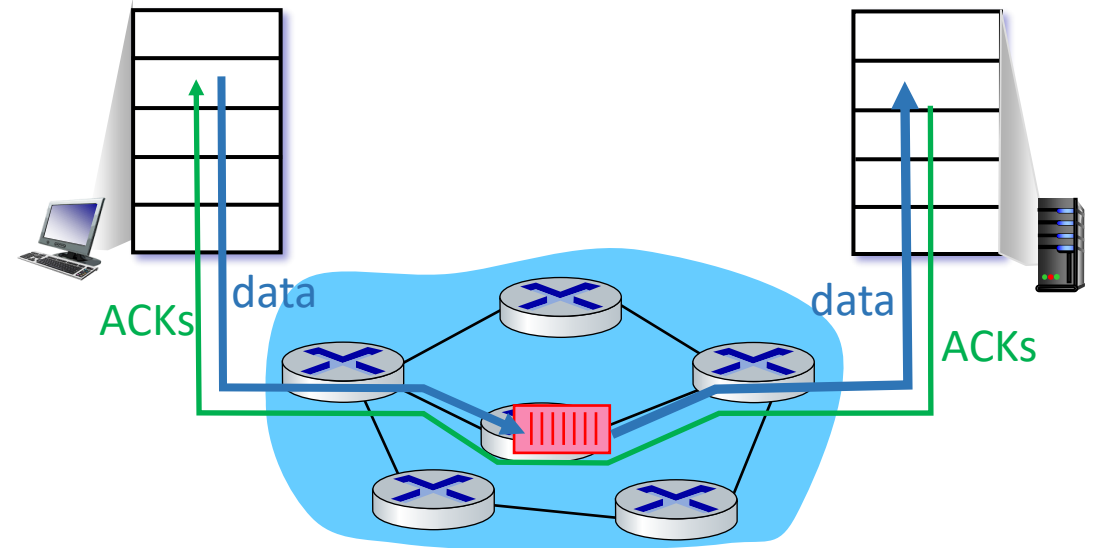

Approaches towards congestion control

Network-assisted congestion control:

- routers provide *direct* feedback to sending/receiving hosts with flows passing through congested router
- may indicate congestion level or explicitly set sending rate
- TCP ECN, ATM, DECbit protocols

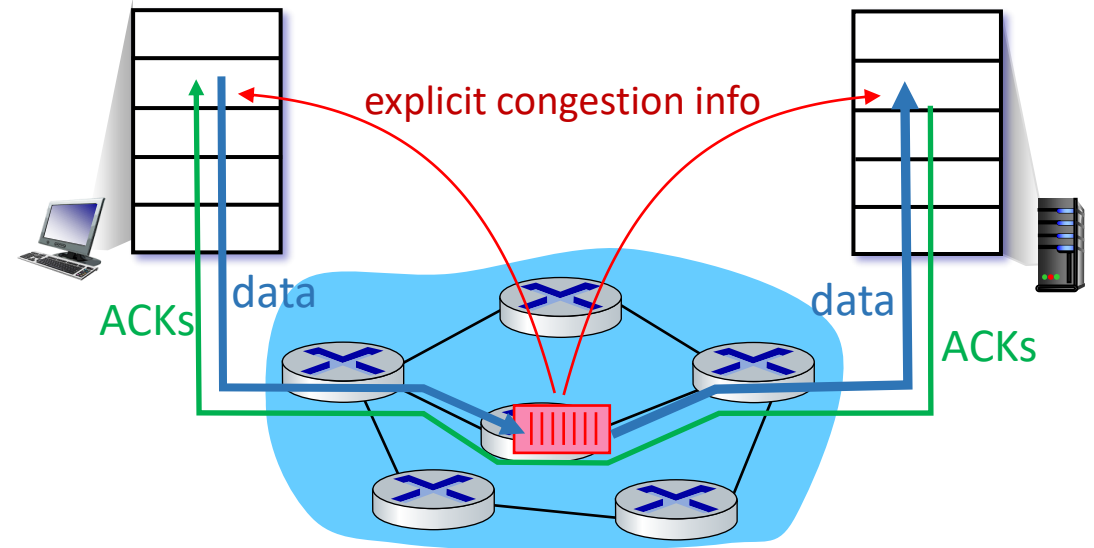

Chapter 3: roadmap

- Transport-layer services
- Multiplexing and demultiplexing
- Connectionless transport: UDP
- Principles of reliable data transfer
- Connection-oriented transport: TCP
- Principles of congestion control
- **TCP congestion control**
- Evolution of transport-layer functionality



TCP congestion control: AIMD

- *approach*: senders can increase sending rate until packet loss (congestion) occurs, then decrease sending rate on loss event

Additive Increase

increase sending rate by 1 maximum segment size every RTT until loss detected

Multiplicative Decrease

cut sending rate in half at each loss event

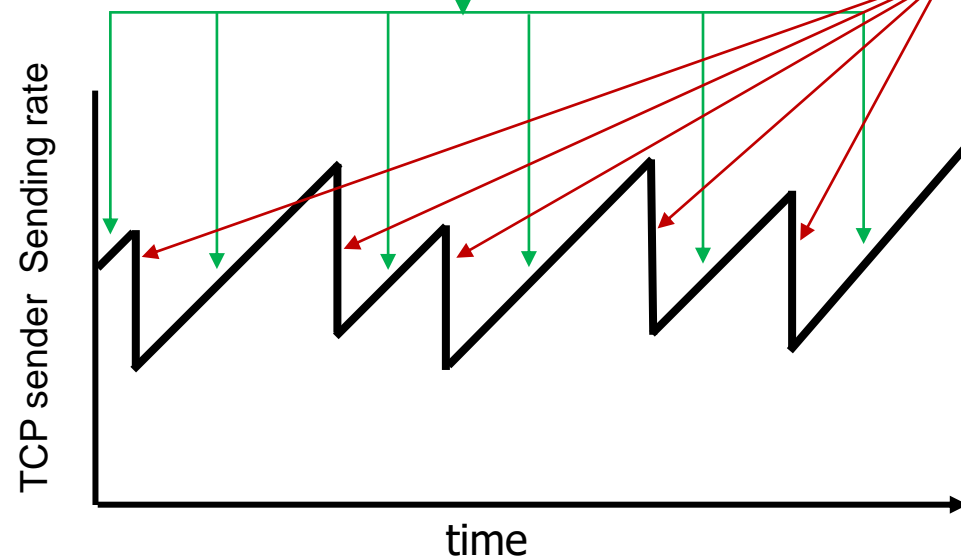

AIMD sawtooth behavior: *probing* for bandwidth

TCP AIMD: more

Multiplicative decrease detail: sending rate is

- Cut in half on loss detected by triple duplicate ACK (TCP Reno)
- Cut to 1 MSS (maximum segment size) when loss detected by timeout (TCP Tahoe)

Why AIMD?

- AIMD – a distributed, asynchronous algorithm – has been shown to:
 - optimize congested flow rates network wide!
 - have desirable stability properties

TCP congestion control: details

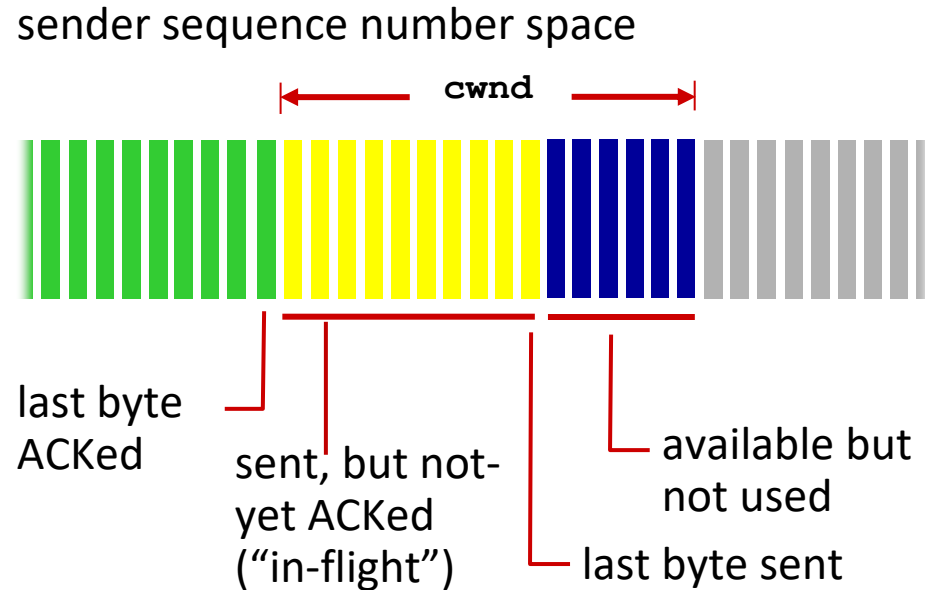

TCP sending behavior:

- *roughly*: send `cwnd` bytes, wait RTT for ACKS, then send more bytes

$$\text{TCP rate} \approx \frac{\text{cwnd}}{\text{RTT}} \text{ bytes/sec}$$

- TCP sender limits transmission: $\text{LastByteSent} - \text{LastByteAked} \leq \text{cwnd}$
- `cwnd` is dynamically adjusted in response to observed network congestion (implementing TCP congestion control)

TCP slow start

- when connection begins, increase rate exponentially until first loss event:
 - initially **cwnd** = 1 MSS
 - double **cwnd** every RTT
 - done by incrementing **cwnd** for every ACK received
- *summary*: initial rate is slow, but ramps up exponentially fast

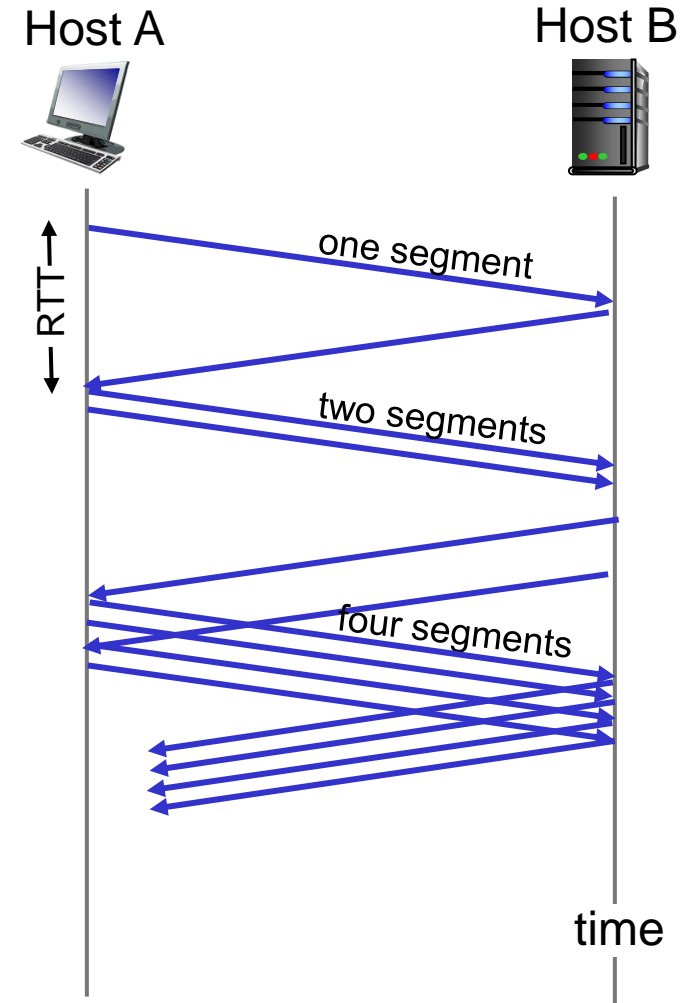

TCP: from slow start to congestion avoidance

Q: when should the exponential increase switch to linear?

A: when **cwnd** gets to 1/2 of its value before timeout.

Implementation:

- variable **ssthresh**
- on loss event, **ssthresh** is set to 1/2 of **cwnd** just before loss event

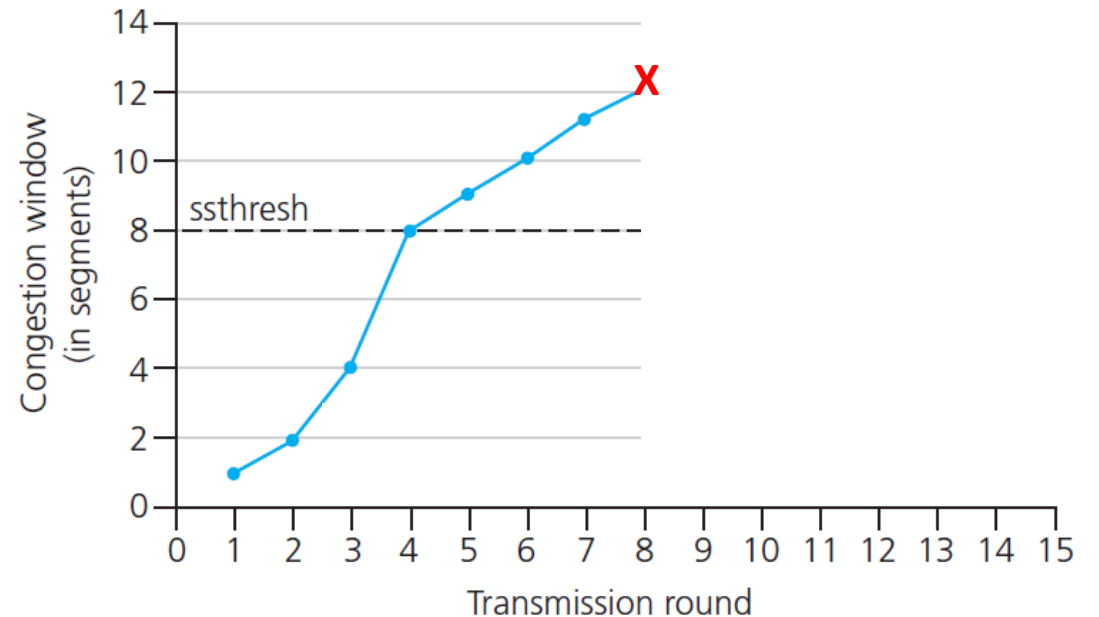

* Check out the online interactive exercises for more examples: http://gaia.cs.umass.edu/kurose_ross/interactive/

Summary: TCP congestion control

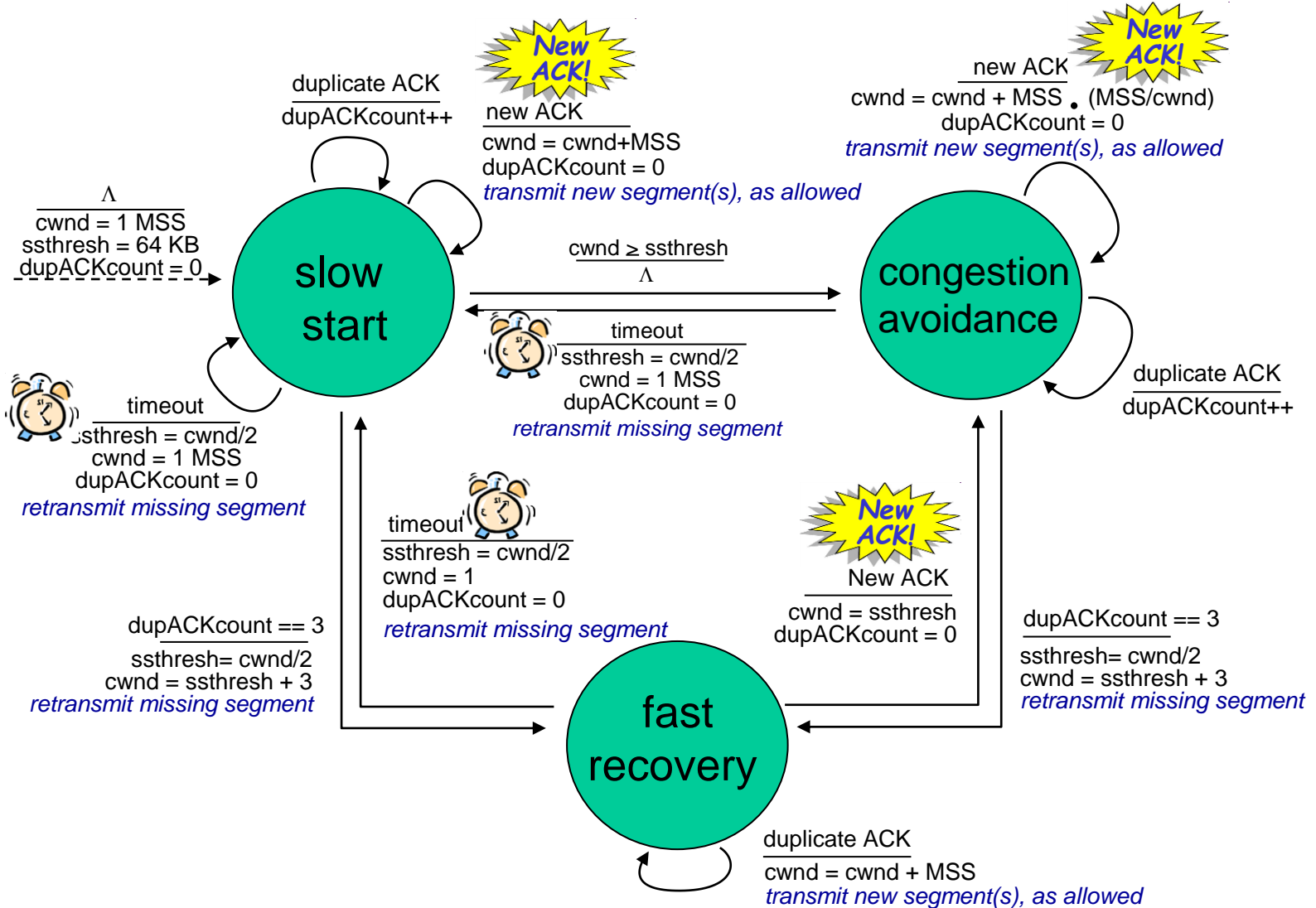

TCP CUBIC

- Is there a better way than AIMD to “probe” for usable bandwidth?
- Insight/intuition:
 - W_{\max} : sending rate at which congestion loss was detected
 - congestion state of bottleneck link probably (?) hasn't changed much
 - after cutting rate/window in half on loss, initially ramp to to W_{\max} *faster*, but then approach W_{\max} more *slowly*

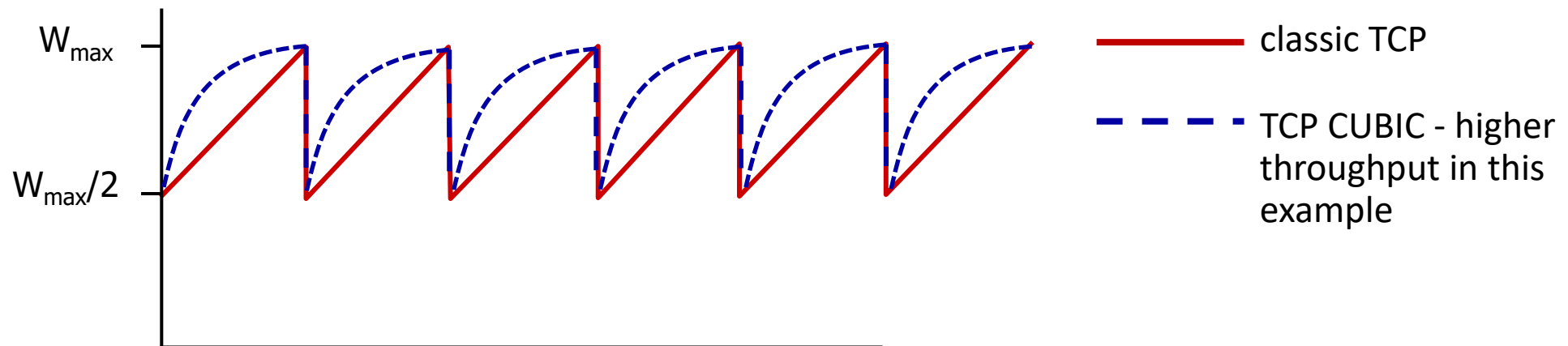

TCP CUBIC

- K: point in time when TCP window size will reach W_{\max}
 - K itself is tuneable
- increase W as a function of the *cube* of the distance between current time and K
 - larger increases when further away from K
 - smaller increases (cautious) when nearer K
- TCP CUBIC default in Linux, most popular TCP for popular Web servers

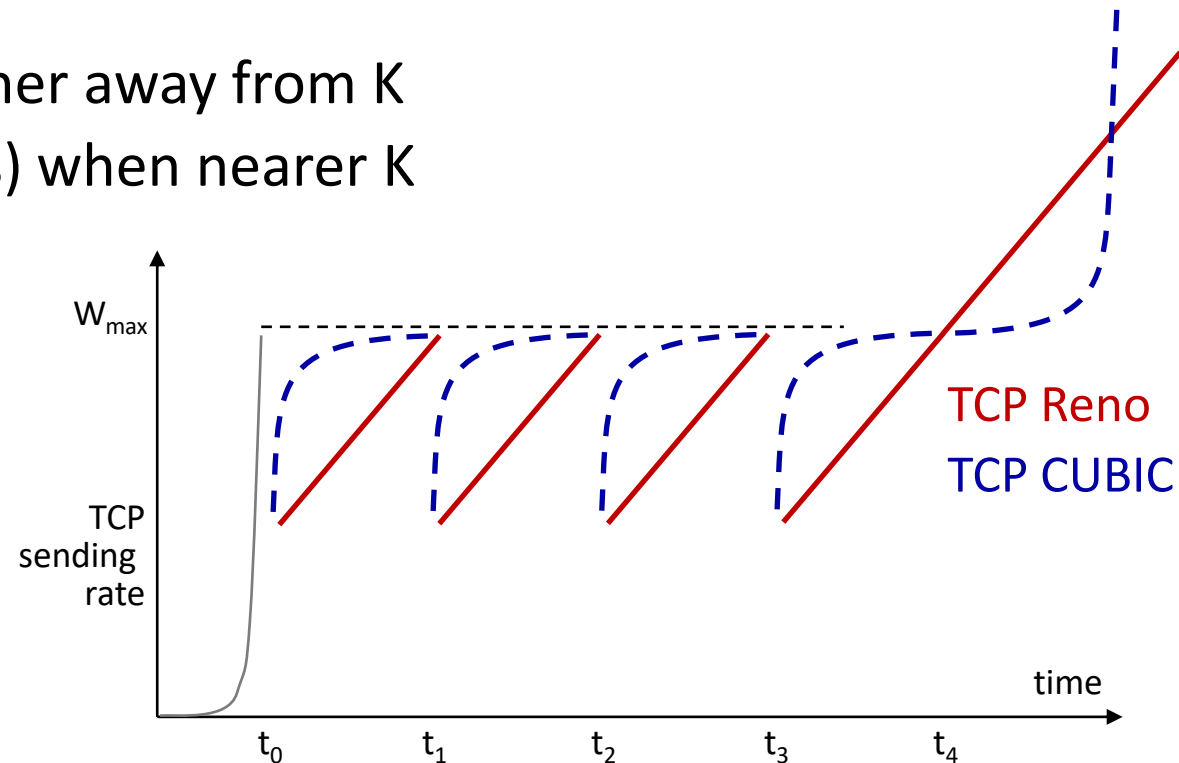

TCP and the congested “bottleneck link”

- TCP (classic, CUBIC) increase TCP’s sending rate until packet loss occurs at some router’s output: the *bottleneck link*

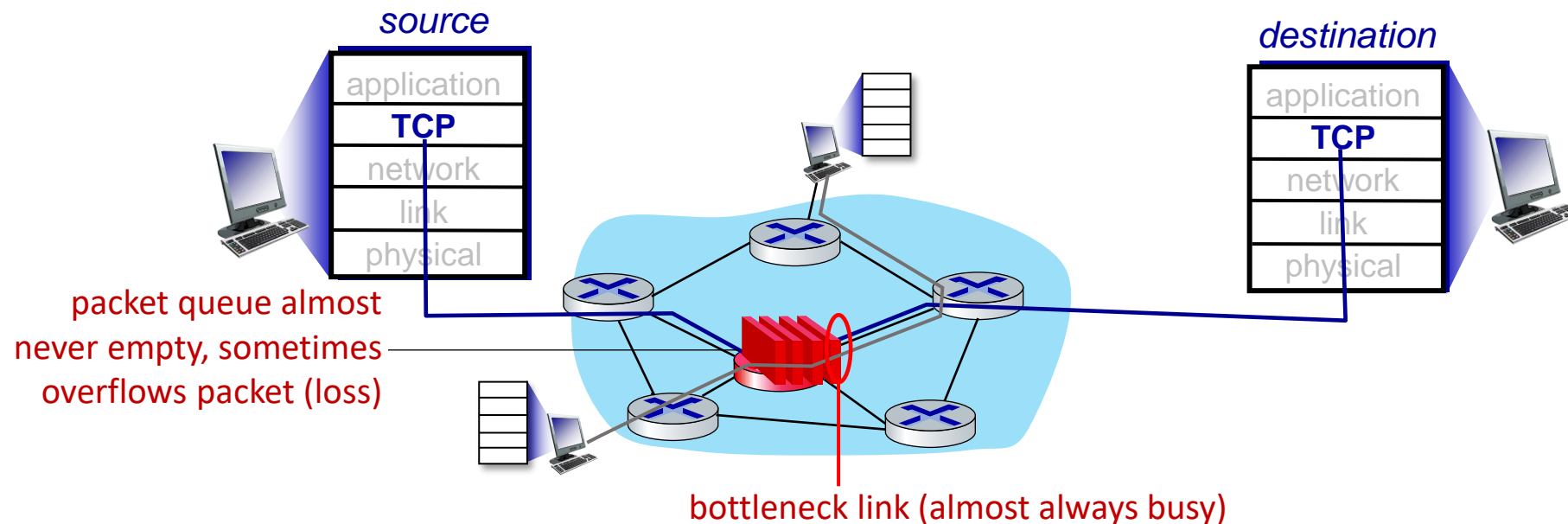

TCP and the congested “bottleneck link”

- TCP (classic, CUBIC) increase TCP’s sending rate until packet loss occurs at some router’s output: the *bottleneck link*
- understanding congestion: useful to focus on congested bottleneck link

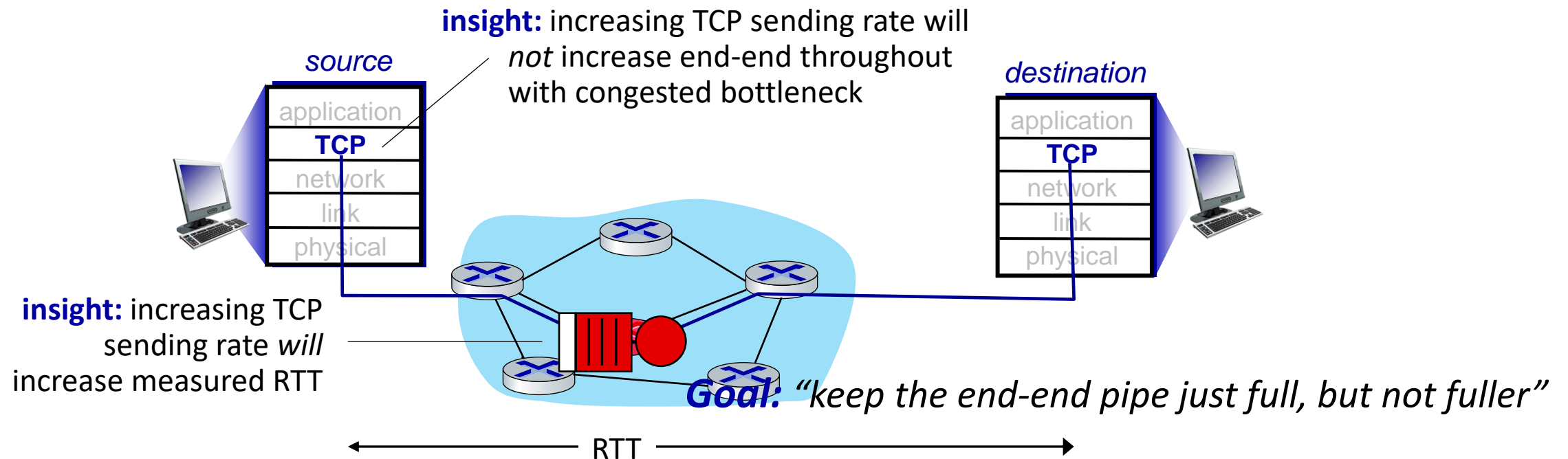

Delay-based TCP congestion control

Keeping sender-to-receiver pipe “just full enough, but no fuller”: keep bottleneck link busy transmitting, but avoid high delays/buffering

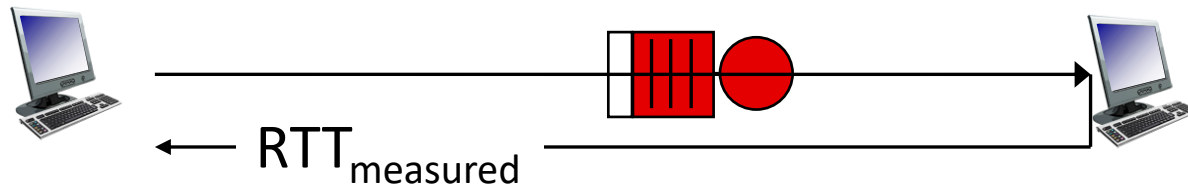

$$\text{measured throughput} = \frac{\text{\# bytes sent in last RTT interval}}{\text{RTT}_{\text{measured}}}$$

Delay-based approach:

- RTT_{min} - minimum observed RTT (uncongested path)
- uncongested throughput with congestion window cwnd is $\text{cwnd}/\text{RTT}_{\text{min}}$

if measured throughput “very close” to uncongested throughput
increase cwnd linearly /* since path not congested */
else if measured throughput “far below” uncongested throughput
decrease cwnd linearly /* since path is congested */

Delay-based TCP congestion control

- congestion control without inducing/forcing loss
- maximizing throughput (“keeping the just pipe full...”) while keeping delay low (“...but not fuller”)
- a number of deployed TCPs take a delay-based approach
 - BBR deployed on Google’s (internal) backbone network

Explicit congestion notification (ECN)

TCP deployments often implement *network-assisted* congestion control:

- two bits in IP header (ToS field) marked *by network router* to indicate congestion
 - *policy* to determine marking chosen by network operator
- congestion indication carried to destination
- destination sets ECE bit on ACK segment to notify sender of congestion
- involves both IP (IP header ECN bit marking) and TCP (TCP header C,E bit marking)

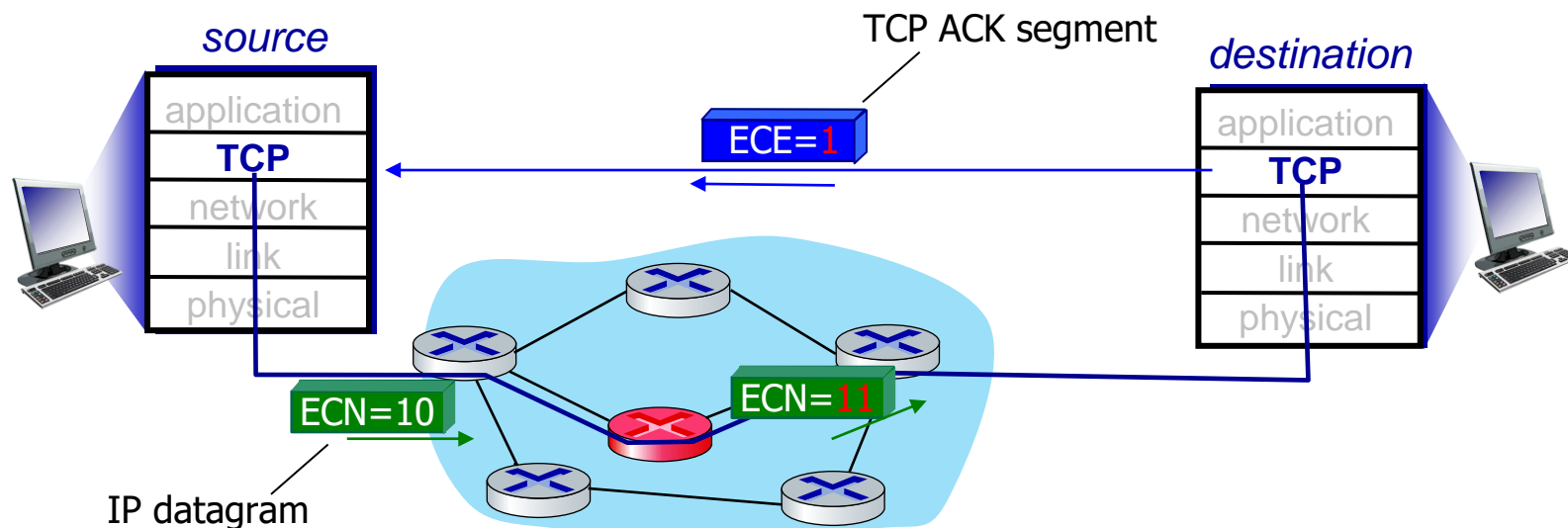

TCP fairness

Fairness goal: if K TCP sessions share same bottleneck link of bandwidth R , each should have average rate of R/K

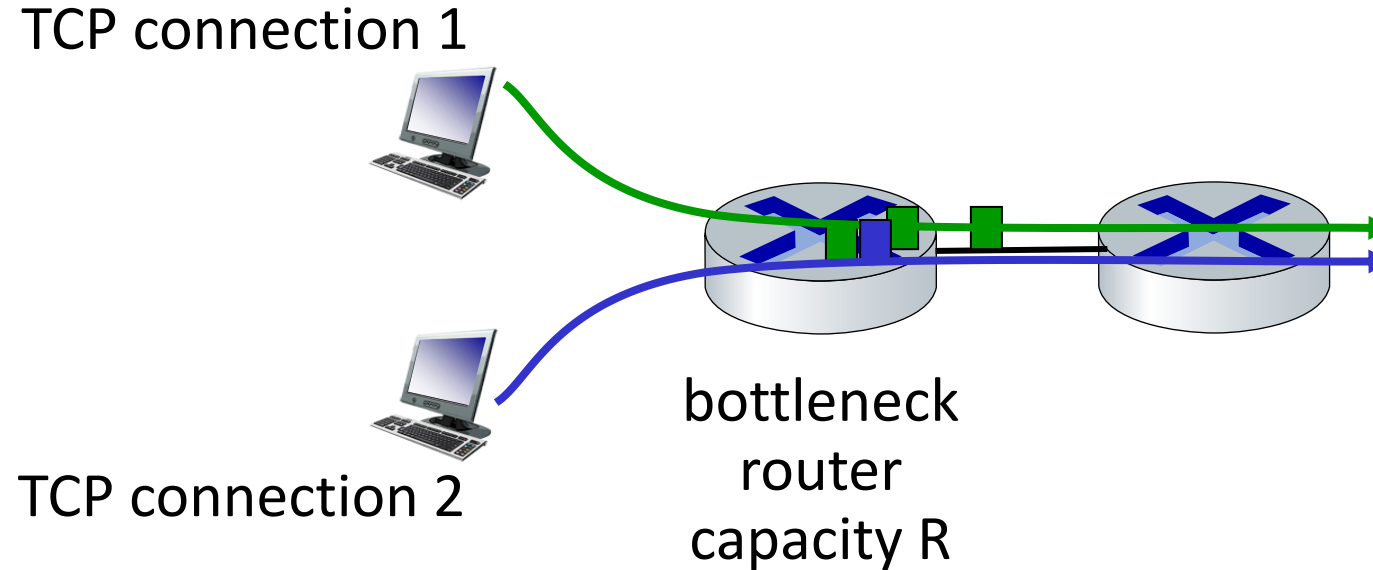

Q: is TCP Fair?

Example: two competing TCP sessions:

- additive increase gives slope of 1, as throughput increases
- multiplicative decrease decreases throughput proportionally

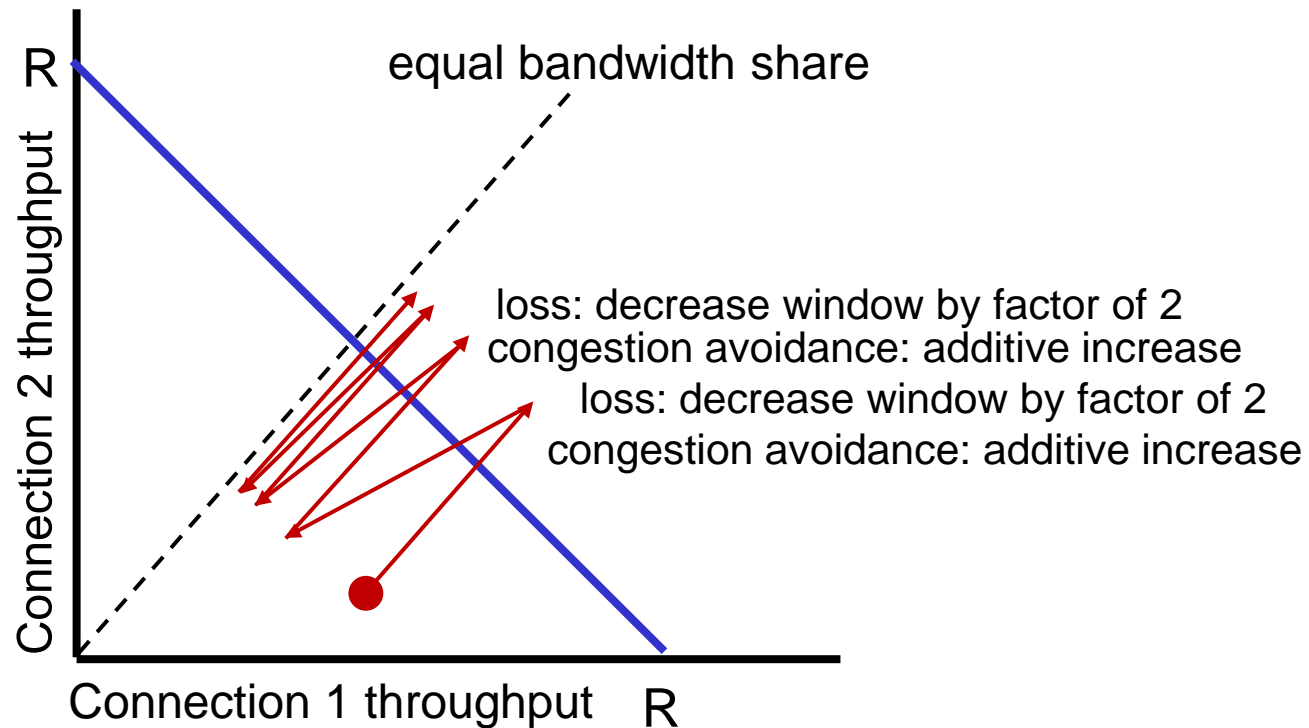

Is TCP fair?

A: Yes, under idealized assumptions:

- same RTT
- fixed number of sessions only in congestion avoidance

Fairness: must all network apps be “fair”?

Fairness and UDP

- multimedia apps often do not use TCP
 - do not want rate throttled by congestion control
- instead use UDP:
 - send audio/video at constant rate, tolerate packet loss
- there is no “Internet police” policing use of congestion control

Fairness, parallel TCP connections

- application can open *multiple* parallel connections between two hosts
- web browsers do this , e.g., link of rate R with 9 existing connections:
 - new app asks for 1 TCP, gets rate $R/10$
 - new app asks for 11 TCPs, gets $R/2$

Transport layer: roadmap

- Transport-layer services
- Multiplexing and demultiplexing
- Connectionless transport: UDP
- Principles of reliable data transfer
- Connection-oriented transport: TCP
- Principles of congestion control
- TCP congestion control
- Evolution of transport-layer functionality



Evolving transport-layer functionality

- TCP, UDP: principal transport protocols for 40 years
- different “flavors” of TCP developed, for specific scenarios:

Scenario	Challenges
Long, fat pipes (large data transfers)	Many packets “in flight”; loss shuts down pipeline
Wireless networks	Loss due to noisy wireless links, mobility; TCP treat this as congestion loss
Long-delay links	Extremely long RTTs
Data center networks	Latency sensitive
Background traffic flows	Low priority, “background” TCP flows

- moving transport-layer functions to application layer, on top of UDP
 - HTTP/3: QUIC

QUIC: Quick UDP Internet Connections

- application-layer protocol, on top of UDP
 - increase performance of HTTP
 - deployed on many Google servers, apps (Chrome, mobile YouTube app)

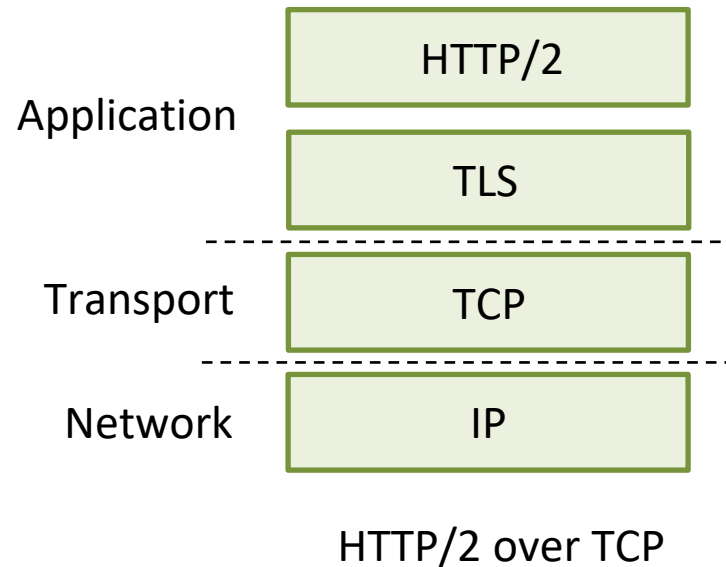

QUIC: Quick UDP Internet Connections

adopts approaches we've studied in this chapter for connection establishment, error control, congestion control

- **error and congestion control:** “Readers familiar with TCP’s loss detection and congestion control will find algorithms here that parallel well-known TCP ones.” [from QUIC specification]
- **connection establishment:** reliability, congestion control, authentication, encryption, state established in one RTT
- multiple application-level “streams” multiplexed over single QUIC connection
 - separate reliable data transfer, security
 - common congestion control

QUIC: Connection establishment

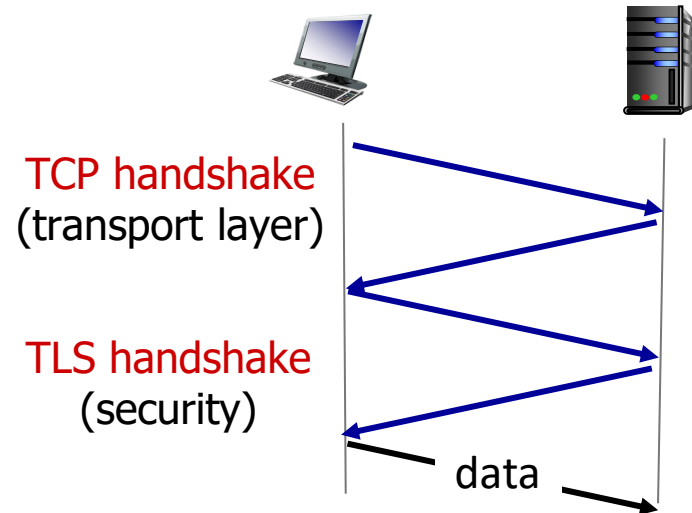

TCP (reliability, congestion control state) + TLS (authentication, crypto state)

- 2 serial handshakes

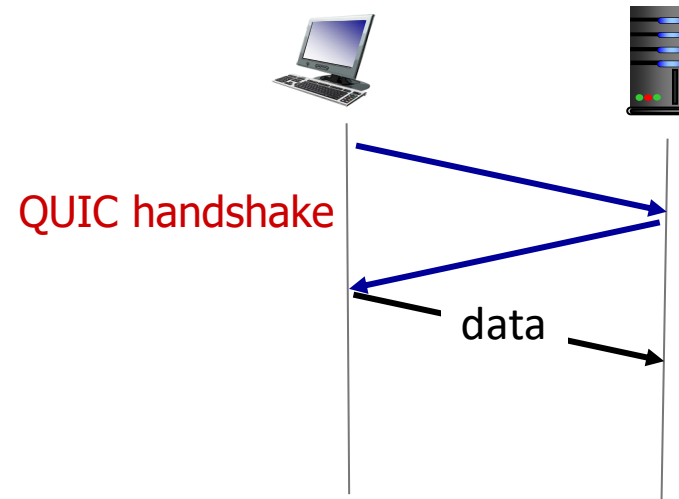

QUIC: reliability, congestion control, authentication, crypto state

- 1 handshake

QUIC: streams: parallelism, no HOL blocking

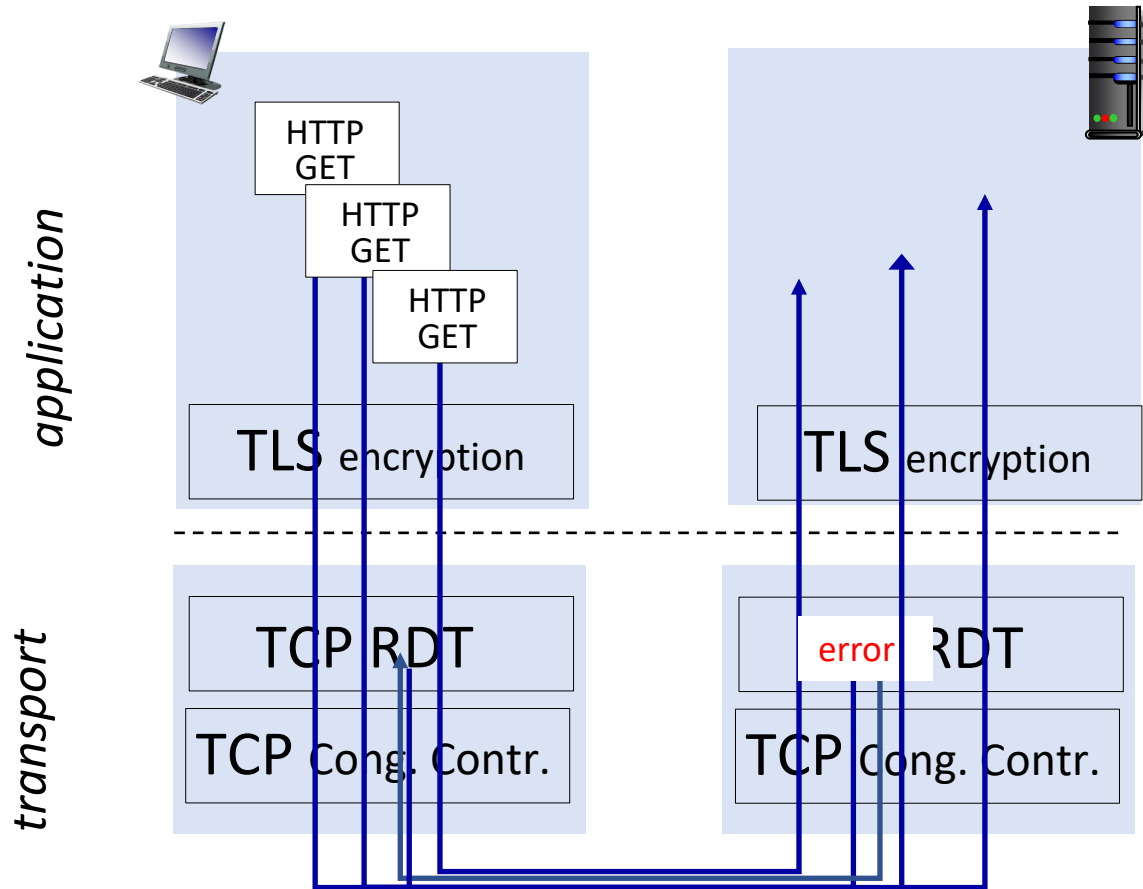

(a) HTTP 1.1

Chapter 3: summary

- principles behind transport layer services:
 - multiplexing, demultiplexing
 - reliable data transfer
 - flow control
 - congestion control
- instantiation, implementation in the Internet
 - UDP
 - TCP

Up next:

- leaving the network “edge” (application, transport layers)
- into the network “core”
- two network-layer chapters:
 - data plane
 - control plane

Additional Chapter 3 slides

Go-Back-N: sender extended FSM

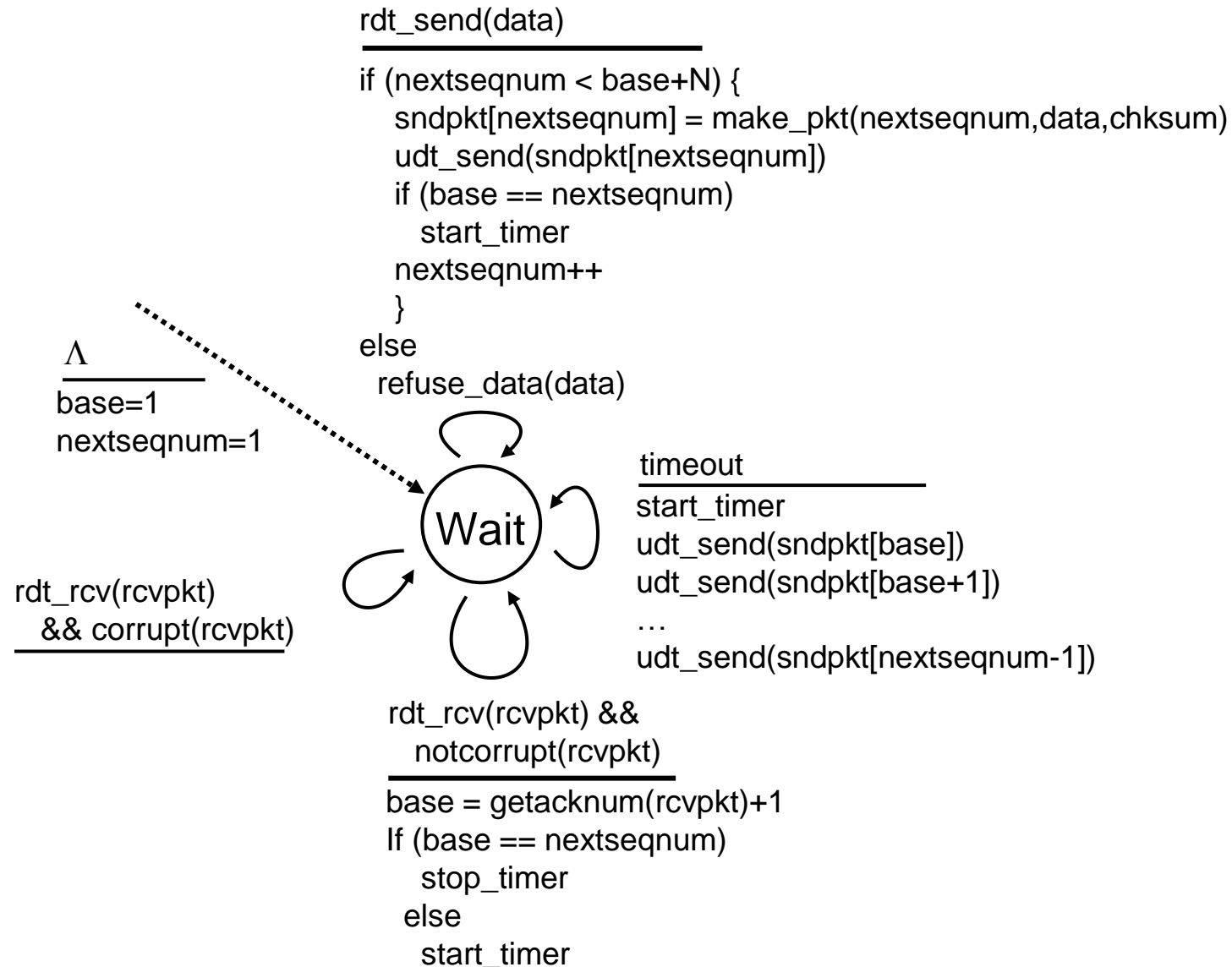

Go-Back-N: receiver extended FSM

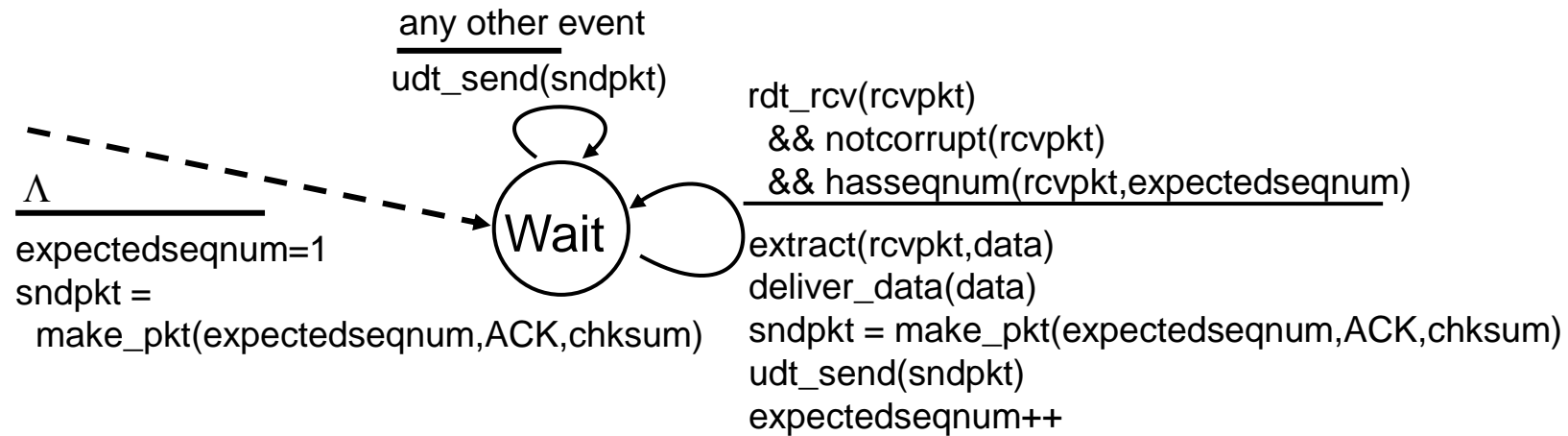

ACK-only: always send ACK for correctly-received packet with highest *in-order* seq #

- may generate duplicate ACKs
- need only remember **expectedseqnum**
- out-of-order packet:
 - discard (don't buffer): *no receiver buffering!*
 - re-ACK pkt with highest in-order seq #

TCP sender (simplified)

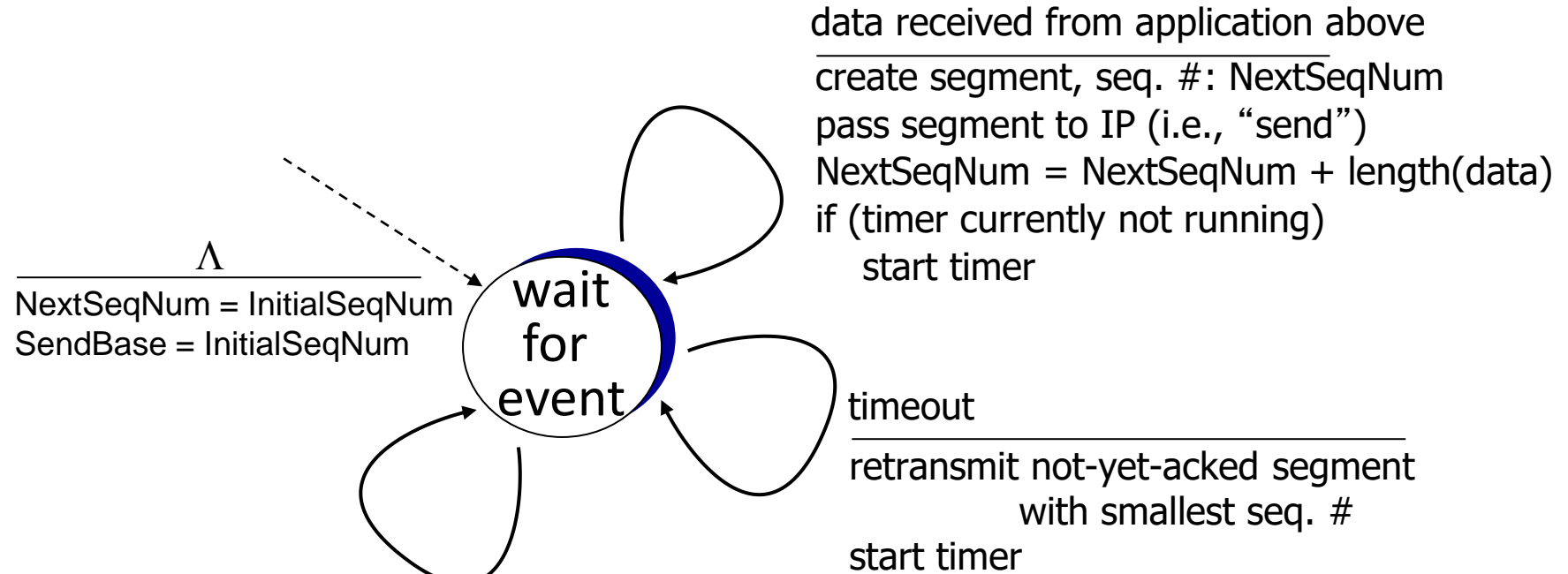

data received from application above
create segment, seq. #: NextSeqNum
pass segment to IP (i.e., “send”)
NextSeqNum = NextSeqNum + length(data)
if (timer currently not running)
start timer

Λ

NextSeqNum = InitialSeqNum
SendBase = InitialSeqNum

timeout

retransmit not-yet-acked segment
with smallest seq. #
start timer

ACK received, with ACK field value y

```
if (y > SendBase) {  
    SendBase = y  
    /* SendBase-1: last cumulatively ACKed byte */  
    if (there are currently not-yet-acked segments)  
        start timer  
    else stop timer  
}
```

TCP 3-way handshake FSM

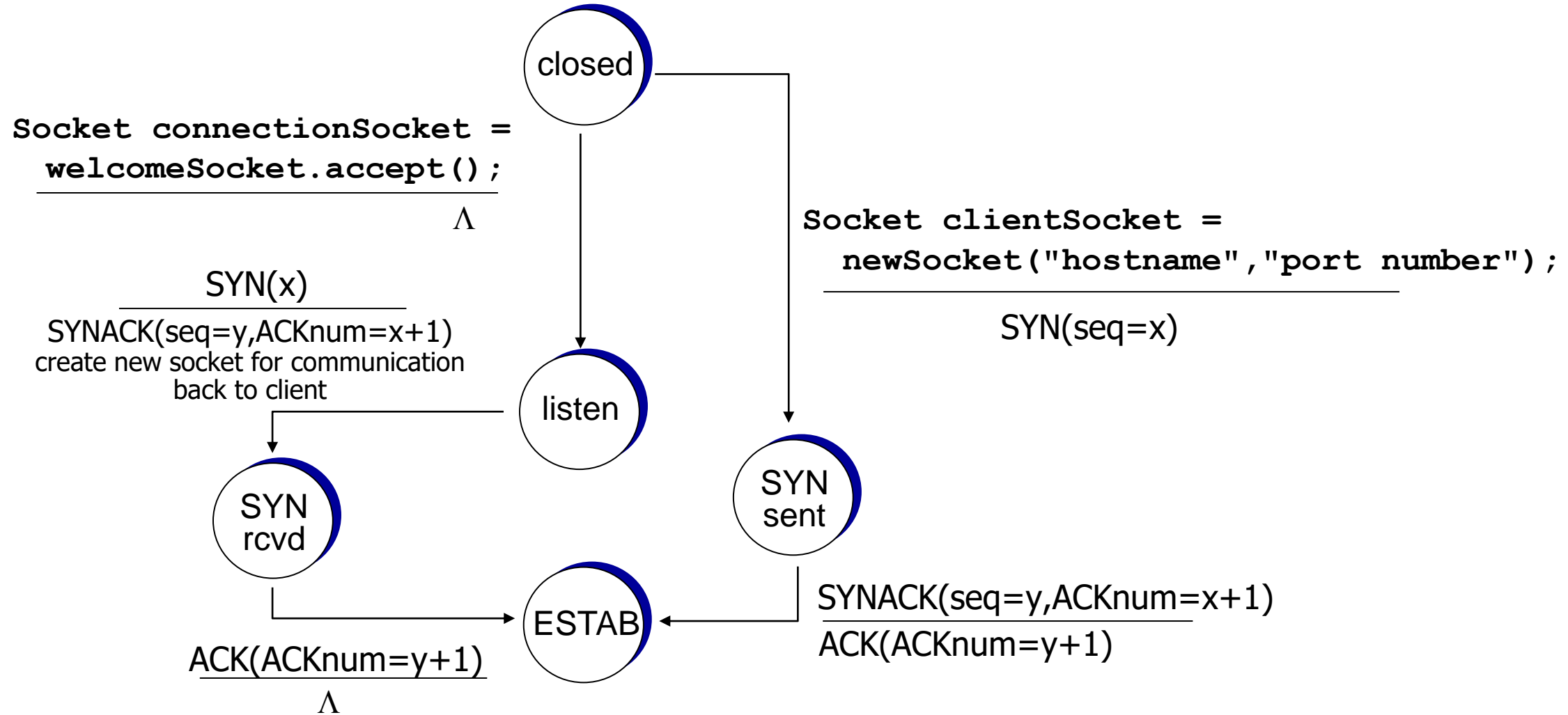

Closing a TCP connection

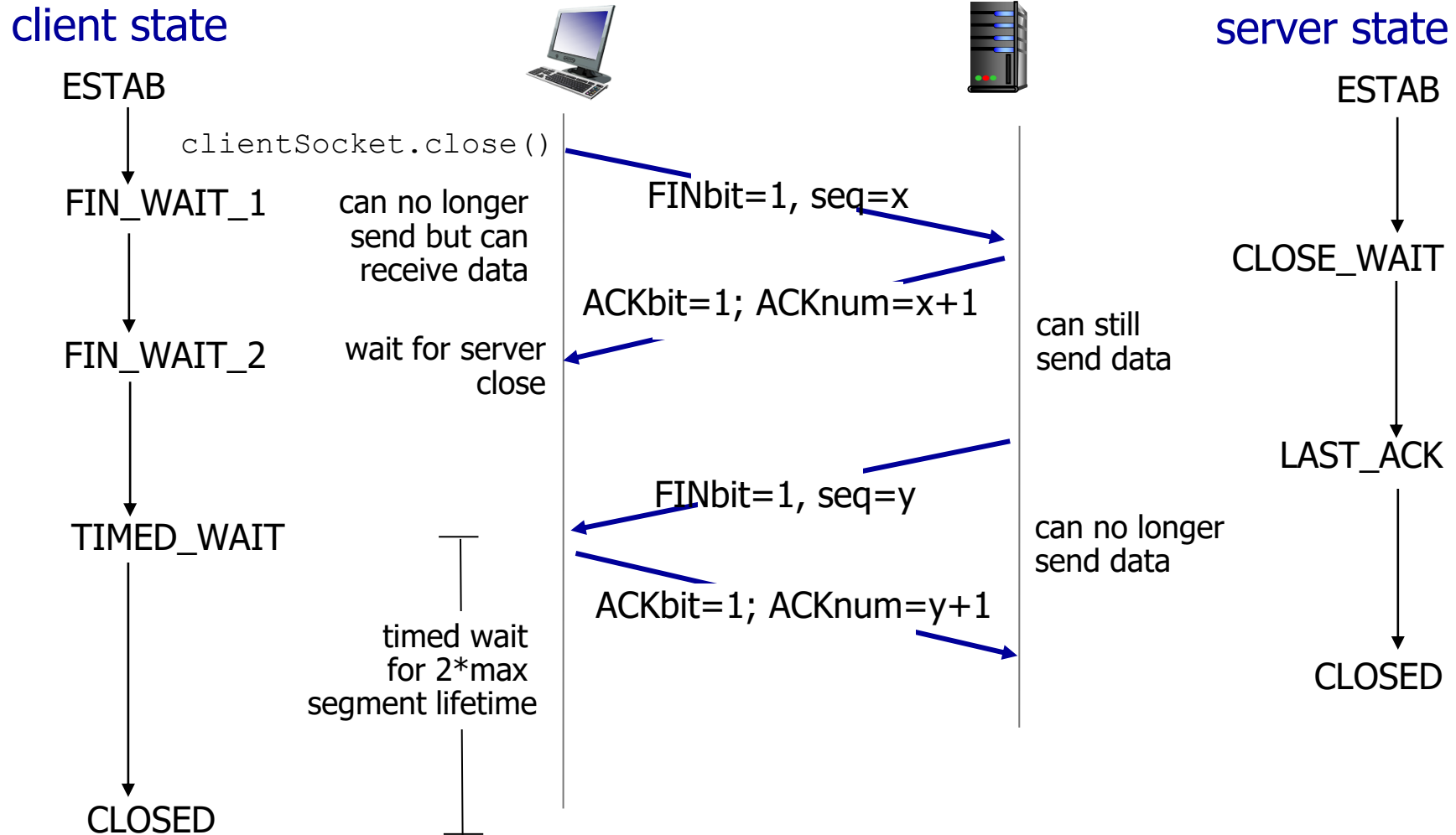

TCP throughput

- avg. TCP thrupt as function of window size, RTT?
 - ignore slow start, assume there is always data to send
- W : window size (measured in bytes) where loss occurs
 - avg. window size (# in-flight bytes) is $\frac{3}{4} W$
 - avg. thrupt is $3/4W$ per RTT

$$\text{avg TCP thrupt} = \frac{3}{4} \frac{W}{\text{RTT}} \text{ bytes/sec}$$

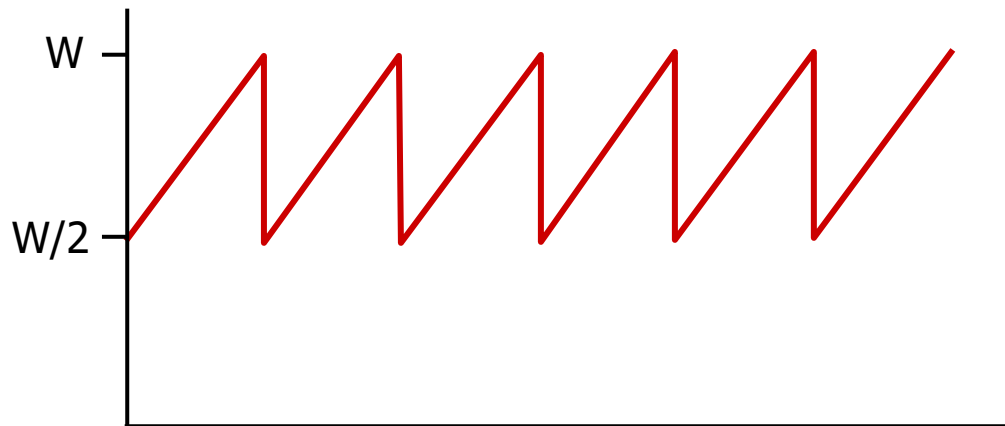

TCP over “long, fat pipes”

- example: 1500 byte segments, 100ms RTT, want 10 Gbps throughput
- requires $W = 83,333$ in-flight segments
- throughput in terms of segment loss probability, L [Mathis 1997]:

$$\text{TCP throughput} = \frac{1.22 \cdot \text{MSS}}{\text{RTT} \sqrt{L}}$$

→ to achieve 10 Gbps throughput, need a loss rate of $L = 2 \cdot 10^{-10}$ – *a very small loss rate!*

- versions of TCP for long, high-speed scenarios